

**STANDARD PROCEDURES for
PROCESSING PRIVATE CONTRACT
SANITARY SEWER PLANS**

DEPARTMENT OF PUBLIC WORKS

THOMAS A TIDEMANSON
DIRECTOR OF PUBLIC WORKS

LAND DEVELOPMENT DIVISION

CARL L. BLUM
Division Engineer
738-2151

BRIAN D. HOOPER
Assistant Division Engineer
738-4051

JOHN SQUIER
Supervising Civil Engineer III
738-4109

REVISED
DECEMBER 1987

INTRODUCTION

This Manual sets forth the standards for the preparation and processing of plans of sanitary sewers to be constructed under a private contract, and all documents supplemental to the plans required by the Department of Public Works for construction of the sewers.

The preparation of plans in conformity with these instructions will expedite the work of checking and shorten the time needed to process them through the Department of Public Works Office.

The preparation and processing of all plans and construction of all sewerage facilities shall comply with the Los Angeles County Code Title 20 - Utilities - Sanitary Sewers and Industrial Waste, the Standard Specifications for Public Works Construction, Special Provisions and Standard Drawings.

Several cities within the County have designated the Director of Public Works as City Engineer and have contracted for engineering services. In such "contract cities," these same procedures and regulations are to be followed, except that all fees (excepting Sewer Maintenance Charges) are paid directly to the city.

These instructions supersede any previous instructions covering the same subjects. Answers to questions on matters of design not covered may be obtained by contacting the Land Development Division Central Office (see title page).

CONTENTS

Introduction

	<u>Pages</u>
PART I SUBMISSION OF PLANS	1
A. Classifications	1
B. Submission of Plans for Processing	2
PART II DESIGN REQUIREMENTS	4
A. Plan and Profile	4
B. Area Study	5
C. Datum Requirements	6
D. Surfaces and Profile	7
E. Underground Utility Interference	7
F. Geologic Investigation	8
G. Index Maps	8
H. Trunk Sewer Connections	9
I. Special Trench Backfill and Pipe Protection in Fill Areas	11
J. Sewage Pump Stations	13
K. Water Pollution Control Plants and Disposal Facilities	13
PART III FEES AND CHARGES	14
A. Payments	14
B. Estimated Valuation	14
C. Refunds	14
D. Required Fees	14
E. Connection Charges	16
F. Sewer Maintenance Charges	16
G. Other Connection Charges	17
PART IV PLAN PROCESSING	18
A. Sanitary Sewer Easements	18
1. Sanitary Sewer Easement Processing Chart	19
B. Letter of Participation	20
C. Offer of Dedication	21
D. Bonds and Agreements	22
E. Road Grade Approval	22
F. Preliminary Plan Approval	23
G. Reimbursement Projects	25
H. Special Studies	27

	<u>Pages</u>
PART V PROJECT COMPLETION	28
A. Required Prints of Approved Plans	28
B. Permits	28
C. Grade Sheet	31
D. Change of Plans	31
E. As-Built Plans	32

	<u>Plate No.</u>
Application for Sewer Plan Check	1
Application for Construction Permit VOID	2
Application for Sewer Easement Processing	3
Application for Sewer Maintenance	4
Letter of Participation	5
Offer of Dedication	6
Sample Index Map	7
Sample Easement Sketch	8
Sample 95% Completion Letter	9
Sample Request for Provisional House Connection Permit	10 & 10A
House Connection Waiver	11
House Lateral Extension Request (During Main Line Construction)	12
House Lateral Extension Request (After Main Line Built)	12A
Underground Letter	13
Reduced Plan and Profile Sheet	14

<u>Standard Charts</u>	<u>Std. Cht. No.</u>
Design Requirements for Sanitary Sewers In the Vicinity of Pressure Water Mains	S-C1
Standard Sewer Grade Sheet	S-C2
Standard Soil Symbols	S-C3
Flow Diagram for the Design of Circular Sanitary Sewers	S-C4
Table for Computing Normal Drops Through Manholes	S-C5

<u>Standard Drawings</u>	<u>Std. Drwg. No.</u>
Legend	S-1
Minimum Public Safety Requirements	S-2
Brick Manhole	S-3
Rectangular Shallow Manhole (Brick)	S-7
Siphon Manhole	S-8
Special Square Base Manhole	S-9
Trap Manhole Base	S-10
Large Gas Trap Manhole Base	S-11

Reconstruction of Brick Manhole Tops	S-12
Breaking into Existing Brick or Precast Concrete Manhole	S-13
Special Manhole Bases	S-14
Rectangular Manhole Frame & Covers	S-16
Standard Manhole Step	S-17
Trap Manhole Casting	S-18
Large Gas Trap	S-19
Temporary Sand Trap	S-20
Bedding for Sewer Pipe	S-21
Bedding for ABS & PVC Sewer Pipe	S-21A
Special Support and Protection	S-22
Cradling and Encasement	S-23
Anchor Block	S-24
Special House Laterals	S-25
Wye or Tee Support	S-26
Chimney Pipe and Base	S-27
Saddles for House Laterals	S-28
Reconstruction of Sanitary Sewer House Laterals	S-29
Erosion Protection in Steep Slopes	S-31
Precast Concrete Shallow Manhole	S-31
Allowable Trench Widths	S-33
Manhole Raising Rings	S-34
Locking Manhole Frame & Cover	S-35
Non-Reinforced Precast Concrete Manhole	S-36
Jacking Pipe	S-37
Sample Plan & Profile (P. C. 13000)	Enclosure

Reconstruction of Brick Manhole Tops	S-12
Breaking into Existing Brick or Precast Concrete Manhole	S-13
Special Manhole Bases	S-14
Rectangular Manhole Frame & Covers	S-16
Standard Manhole Step	S-17
Trap Manhole Casting	S-18
Large Gas Trap	S-19
Temporary Sand Trap	S-20
Bedding for Sewer Pipe	S-21
Bedding for ABS & PVC Sewer Pipe	S-21A
Special Support and Protection	S-22
Cradling and Encasement	S-23
Anchor Block	S-24
Special House Laterals	S-25
Wye or Tee Support	S-26
Chimney Pipe and Base	S-27
Saddles for House Laterals	S-28
Reconstruction of Sanitary Sewer House Laterals	S-29
Erosion Protection in Steep Slopes	S-31
Precast Concrete Shallow Manhole	S-31
Allowable Trench Widths	S-33
Manhole Raising Rings	S-34
Locking Manhole Frame & Cover	S-35
Non-Reinforced Precast Concrete Manhole	S-36
Jacking Pipe	S-37
Sample Plan & Profile (P. C. 13000)	Enclosure

PART I

SUBMISSION OF PLANS

A. CLASSIFICATIONS

Private contract sanitary sewer projects processed through the Department of Public Works are classified as follows:

1. Private Contracts in Unincorporated Area

Plans designed for the construction of sewage facilities serving areas in unincorporated territories of Los Angeles County.

2. Private Contracts in Contract Cities

Plans designed for the construction of sewage facilities serving areas in a contract city.

3. Private Contract Involving Reimbursements

Any private contract involving reimbursement processing in accordance with Section 20.28.050 of the Los Angeles County Code-Title 20, under Section 66485 of the Business and Professions Code, Section 15007 of the Education Code, Sections 23010.3 and 50140 of the Government Code of the State of California, or under special city procedures. Refer to Part IV, Section G of this Manual for further details.

4. Private Contracts for the Construction of Private Sewers

Occasionally, a private contract sewer serving only a single property must be constructed in accordance with Los Angeles County Code-Title 20. The Building and Safety Division will make recommendations regarding facilities which cannot be sewered in accordance with the Plumbing Code (Title 28). Normally sewers of this type are to serve large industrial developments. If in the future this "private sewer" is extended-public easements and offers of Dedication will be required.

5. Preliminary Private Contract Plans for Subdivisions

Preliminary sewer plans are processed for subdivisions, either in the County, or a contract city, for which a Bond and Agreement is required as a condition for filing of the tract. However, final sewer plans must be approved prior to the issuance of the construction permit. See Part IV, Section F of this Manual for further requirements

6. Water Pollution Control Plant and Sewage Pumping Stations.

Public water pollution control plants, disposal systems, and sewage pump stations must be plan-checked, approved and inspected by the Department of Public Works. Also, privately owned sewage pumping or lift stations which are part of a private or building sewer as required by subsection (f) of Section 1105 of the Plumbing Code, including private pumping stations which discharge directly into a public sewer through a large or extensive force main, must be processed as a private contract through the Land Development Division. Plans are processed through the Sewer and Water Design Section of the Design Division.

B. SUBMISSION OF PLANS FOR PROCESSING

Sanitary sewer plans must be prepared and signed by a Civil Engineer registered in the State of California.

The processing of a private contract will not commence until the required plan checking fees have been submitted. The items necessary for plan check include:

1. Required plan checking fee. If improvement is located within a contract city, this fee shall be deposited with the city.
2. If project involves easement acquisition, required sketches and fees must be submitted.
3. Two ozalid blue line prints of plans.
4. Separate reproducible index map.
5. Area study.
6. Field notes showing ties to existing outlet sewer, elevations of existing inlets and outlets, and existing elevations of surface over proposed sewer.
7. Approved road plans are required if public sewers are to be located in dedicated or private streets of a new subdivision.
8. Plot plan and approved grading plan on certain projects.

9. Print of approved private drain plans where drainage structures are required.
10. Print of tract or parcel map for all such developments.

The above listed items are fully described elsewhere in this Manual. Private contract sanitary sewer plans are checked and approved in the Road, Sewers and Water Section of the Land Development Division and then transmitted by the engineer for final approval to the agency responsible for treatment and disposal of the sewage.

The plans will be checked for accuracy, compliance with Public Works Standards, and conformity with prevailing laws and ordinances. Before the checking can be completed, you will be required to submit the necessary Letters of Participation, Offers of Dedication, Underground Letters, Bonds and Agreements, and other required documents, fees and deposits.

PART II
DESIGN REQUIREMENTS

A. PLAN AND PROFILE

1. Sample Plan and Profile

A sample plan and profile is enclosed with this Manual. Current procedures and instructional notes have been shown and referral to these plans will answer many questions.

2. Standard Sheet Size

Standardized tracing cloth sheets (32 inches long) with preprinted title pages are available from local blueprint agencies. The use of these sheets will greatly expedite plan and profile preparation. Upon complete approval of the plans, these sheets become the property of the County of Los Angeles.

3. Depth of Main Line Sewer

The minimum depth of a residential sewer is that depth necessary to obtain a house lateral depth of 6 feet below curb elevation at property line. The depth is 7.5 feet if the grade of curb is accurately known and 8.0 feet if curb grades are accurate to +6 inches. However, in some cases, if the existing outlet sewers are too shallow to obtain such a depth, a shallower depth may be approved. The County may require greater depths when it is necessary to extend the main line sewers to serve other areas.

4. House Lateral Sewers

A 4-inch or 6-inch internal diameter house lateral sewer shall be provided in the street from the main line sewer to the property line for each lot as specified in Section 20.32.510 of Los Angeles County Code-Title 20.

5. Depth of House Laterals

a. The minimum depth at the property line for house laterals shall be 6 feet below the curb grade or street center line as specified in Section 20.32.520 of Los Angeles County Code-Title 20.

- b. Depth shall also be sufficient to provide service to the lowest or farthest point to be served on each lot at a minimum grade of 2% with not less than two feet of cover over the top of the pipe. A subminimum grade of 1% on private property may be acceptable if approved by the Building and Safety Division.
- c. When ground water is present the depth of house laterals at the property line may be 5 feet below the curb grade or street center line.
- d. Where street widening lines have been established by Title 22, the Zoning Ordinance, the minimum depth shall be measured at such established lines. If house laterals are constructed before the existing street is widened, the depth at the property line shall be such that extension at the same straight grade and alignment to the new property line will produce the required depth.

B. AREA STUDY

An area study must be made for all private contract sewer projects. The private engineer should consult with the Road, Sewers and Water Section of the Land Development Division whenever there are questions on the study area. Normally the area study should be made in pencil on vellum to a scale of 1"=600'. The study must show not only the district being served but all areas tributary to the sewers under study. A North Point must be shown normally pointing towards the top of the sheet.

As an adequate area study is necessary to determine depth, capacities, and other critical design data, it is required that the study show the following:

1. Major street names.
2. Contour lines (on back of vellum).
3. Zoning, when it will affect the quantities.
4. Existing or proposed utilities, storm drains, State highways, etc. which may have a bearing on sewer design.
5. Sanitation District, Municipal Water District, Improvement District, Reimbursement District, City and other boundary lines of influence.
6. Depths of existing sewers that could be used for an outlet connection where depth is critical.

7. Tributary areas served should be identified and acreages should be noted. Color contributing areas by outline only on the back of the vellum so prints can be made.
8. Capacities of existing systems shall be thoroughly investigated and noted.
9. Existing and proposed sewers showing pipe size and grade should be identified.
10. Directions of sewer flows if not clearly understood.
11. Existing and proposed pipe sizes over 8 inches in size and grades in critical areas.

C. DATUM REQUIREMENTS

The elevation shown on all sewer plans must be the Sea Level Datum of 1929, as established by the U.S. Coast and Geodetic Survey.

Information and recent adjusted elevations of established bench marks may be obtained by contacting the Survey Division, by telephone, 226-8257.

Bench marks are assigned to all tracts by the Road Element of the Department of Public Works. The elevation of all existing inlets and outlets relative to a sewer design must be determined by actual field survey. These field notes must be submitted by the private engineer when the sewer plans are submitted for checking. In no case will there be any equation between the elevations as shown on the profile and the acceptable bench mark.

The bench mark note is to appear in the upper left hand corner of Page 1 of the plans (Title Page).

The bench mark is to be shown within a flag as noted below.

	<u>Name or Number</u>	<u>USC & G ELEV.</u>	<u>Book</u>	<u>Page</u>
Line 1.	"H-145"	726.142 feet	CEFB 852	92
	<u>General Location</u>			
Line 2.	City of South El Monte, 1st Avenue and 2nd Street, N.E. Corner.			
	<u>Specific Point</u>			
Line 3.	Spk. in P. P. So. Cal. Ed. Co. No. 699454 or L & T 5' E of East end of C.R.			

EXAMPLE:

BM H-145 Elev. 726.142 CEFB 852-92

City of South El Monte, 1st Avenue and 2nd Street NE
Cor. L & T 5' E of East end of C.R.

D. SURFACES AND PROFILE

It is very important that the elevation of the existing ground surface or of the proposed finished surface be shown on the profile. This surface serves to determine the elevation at which the main line sewer and the house laterals are designed. Refer to the Sample Plan and Profile for information concerning the proper method of showing curb grades, top of manhole elevations, grades for alleys, surface over sewer and grade of street center line.

E. UNDERGROUND UTILITY INTERFERENCE

One of the most important design requirements of a sewer plan is the study of existing, and, in some cases proposed, underground pipes and utilities. These will affect both the location and depth of the main line sewer and house laterals.

1. Source of Information

Prior to beginning the sewer layout, acquire data of existing or proposed pipes and utilities from the Construction Division, Underground Section, and the private or public companies involved.

The County is not responsible for the accuracy of the location of these underground lines, and a note to this effect is required on the Title Page of each plan.

2. Showing Underground Lines on Plans

Show and label and dimension on the plan all existing underground work that crosses or parallels the sewer, the size of pipe or conduit, and the name of the company owning it. Show, label and dimension on the profile all telephone, gasoline and oil lines, and any other line 12" or more in diameter. In the event any proposed underground work, such as a large storm drain, necessitates a special design of the sewer, show the proposed work by dashed lines in both Plan and Profile and designate thus: "Proposed 48" Storm Drain." Careful studies should be made of gas, gasoline and oil lines, which, if broken during construction, could cause considerable damage and injury.

3. Required Letter

A form letter (refer to Plate No. 13) is furnished to the designing engineer during the plan checking. This

letter must be completed and signed by the Registered Engineer preparing the sewer plans.

4. Design Criteria Near Water Wells and Mains

The location of water well sites in the vicinity of a proposed sewer must be thoroughly investigated. If design requirements dictate that a sewer or structure be closer than 50 feet to a water well, special approval must be obtained from local health agencies. The Road, Sewers and Water Section of the Land Development Division should be contacted regarding such situations prior to design.

Refer to Standard Chart S-C1 for the design requirements of a sewer to be constructed in the immediate vicinity of pressure water mains.

Note: When a main line sewer is being designed parallel to a water line, a minimum of 10 feet of clearance must be maintained between the outsides of the two pipes. Any distance less than 10-feet requires special approval.

F. GEOLOGIC INVESTIGATION

The Department of Public Works requires the drilling of test holes in any area suspected of having high perched ground water or peculiar soil conditions. These test holes may be made with a regular post-hole digger and should be dug at least two feet deeper than the proposed sewer depth. This is mandatory in the design of a sewage pump station. The results of the test holes must be shown on the plans. Refer to Standard Chart S-C3 for standard soil symbols and a standard test hole symbol used by this office. Particular attention is directed to the elevations on the test holes. It is mandatory that the elevation of the top of the test hole be shown on the plans. The location of the test holes must be shown on the Index Map on Page 1 of the plans.

Test holes are required so that construction conditions will be known, and necessary design procedures can be shown beforehand.

A geologic investigation and approved grading plans may be required to ensure that the proposed main line and house lateral sewers will be constructed in stable ground.

G. INDEX MAPS

Index maps for all private contract sanitary sewer projects, besides appearing on Page 1 of the plans, must also be made on a separate drawing. Such maps will be drawn on tracing cloth or vellum 8-1/2" x 11" in size.

1. A scale of 1" = 600' is to be used.

2. At least one major intersection must be shown on the map for orientation.
3. North Points must point up or to the left.
4. Show streets, alleys, rights of way, and railroads with appropriate labels on the map. Show and label all existing sewers in the vicinity. All sewers greater than 8 inches in diameter should be labeled showing pipe sizes.
5. Show the sewer to be constructed with heavy solid lines and indicate plan page numbers in circles.
6. City boundary lines must also be shown and labeled. Use a medium dash-double dot line.

Refer to Plate No. 7 for a sample Index Map and the information to be shown in the title block.

H. TRUNK SEWER CONNECTIONS

Before designing a connection to a trunk sewer, it is always necessary for the private engineer to contact the outlet agency to determine their requirements. They will designate the method and at what point and elevation to make the connection. Agencies providing trunk sewer outlet systems include the following:

- a. Los Angeles County Sanitation Districts
1955 Workman Mill Road
Whittier, California 90601
Telephone (213) 699-7411, ext. 417
- b. Las Virgenes Municipal Water District
4232 Las Virgenes Road
Calabasas, California 91302
Telephone (818) 880--4110
- c. Newhall County Water District
24356 San Fernando Road
Newhall, California 91321
Telephone (805) 259-3610

All inlets shall be designed so as to minimize turbulence in the manhole. Copies of letters to or from County Sanitation Districts, Las Virgenes Municipal Water District, and Newhall County Water District regarding connections to a trunk sewer should be submitted to the Road, Sewers and Water Section of the Land Development Division during plan checking.

1. Trap Manholes.

Trap manholes are installed in collector sewer lines which outlet into a trunk sewer in order to provide a water seal which prevents any gases present in the trunk sewer from reaching the local sewer system.

Under present operating conditions, trap manholes must be installed in all local sewers in metropolitan areas which connect to a trunk sewer, except:

- a. Baldwin Hills (Sanitation District No. 11).
- b. West Hollywood and Sherman (Sanitation District No. 4).
- c. All areas north of the Monterey Hills and Puente Hills (Sanitation District Nos. 15, 16, 17, 21 and 22).
- d. Lancaster and Palmdale (Sanitation District Nos. 14 and 20).
- e. Saugus-Newhall area (Sanitation District Nos. 26 and 32).
- f. Las Virgenes Municipal Water District.

However, no trap manhole is required if the inlet is from a sewer which is not over 350 feet long, has only one manhole which is located at its end, and is never to be extended. Each house lateral from such a sewer must contain a running gas trap as specified in Section 1105.d of the Plumbing Code, which states the type, location and size required.

Double trap manholes may be used, but shall be included in a design only when necessary. Triple trap manholes are not acceptable. In such cases, a junction chamber with three inlets shall outlet into an additional manhole which is a single trap manhole, which in turn outlets into the trunk sewer.

The invert elevation of the inlet to, and the outlet from, a trap manhole, shall be the same. However, if design considerations make it necessary, the outlet may be 0.05 foot lower than the inlet.

For details of a Trap Manhole Base and Castings for sewers of not more than 12 inches in diameter, refer to Standard Drawings, S-10 and S-18.

For details of a Trap Manhole Base and Castings for sewers of fifteen inches in diameter or more, refer to Standard Drawings, S-11 and S-19.

2. Running Trap.

A running trap is required on every house connection made directly to a trunk sewer.

I. SPECIAL TRENCH BACKFILL AND PIPE PROTECTION IN FILL AREAS

In order to design sewers which are to be constructed in filled ground, the relative compaction of the soil must be known. However, in the case of Private Contract projects, the sewers must often be designed before the fills are made.

The following design criteria have been developed to insure that sewers will not fail due to uneven settlement in filled areas, creating a health and safety hazard and a major maintenance problem.

1. Designation of Filled Areas

All proposed or completed filled areas must be shown on the profile. The finished surface over sewer or curb grade must be shown by a solid line; and the original surface by a dashed line labeled "Original Ground Surface." The filled area shall be labeled "Compacted Fill" with arrows to the limits.

2. Trench Backfill in Fills Within New Subdivisions

All trench backfills within new subdivisions shall meet the requirements of the grading plan approved by the Building and Safety Division.

Trenches within street areas shall be backfilled in accordance with Section 306 of the Standard Specifications for Public Works Construction and the Special Provisions for the Construction of Sanitary Sewers.

Trenches within easements shall be compacted sufficiently to meet the requirements of the grading plan. This can be accomplished by backfilling to one foot above the pipe with sand and the remainder backfilled in layers not exceeding four inches in thickness with each layer dampened and thoroughly mechanically tamped as specified in Section 306 of the Standard Specifications for Public Works Construction and the Special Provisions for the Construction of Sanitary Sewers.

The following procedures should be noted on the plans for any sewers within easements within the new tract:

- a. Show the following note within each area affected with the limits arrowed:

"SPECIAL COMPACTION REQUIRED-SEE NOTE (X), PAGE 1"

b. Add the following note to general notes, page 1:

(X) SPECIAL BACKFILL IN DESIGNATED AREAS

(a) BACKFILL TRENCH AND REPLACE OTHER EARTH REMOVED SO AS TO ACHIEVE THE NATURAL OR FINISHED GRADES AND SLOPES SHOWN ON THE GRADING PLAN APPROVED FOR THIS TRACT BY THE BUILDING AND SAFETY DIVISION.

(b) ALL BACKFILL AND EARTH REPLACED SHALL BE COMPACTED TO A MINIMUM OF 90% OF MAXIMUM DENSITY PER A.S.T.M. STANDARD METHOD OF TEST D698-57T AS MODIFIED. ACCEPTABLE CERTIFICATION OF SUCH COMPACTION SHALL BE SUBMITTED TO THE CONSTRUCTION INSPECTION SECTION OF THE CONSTRUCTION DIVISION.

3. Trench Backfill In Existing Fill Areas

Sewer trench backfilling in fill areas outside of new tracts must be thoroughly reviewed. The Standard Specifications for Public Works Construction and the Special Provisions for the Construction of Sanitary Sewers would apply in such cases for surface restoration, and reference to the grading plan is not necessary. Note (a) under X would not be shown on the plans.

If a fill area is encountered either in a street or easement which has less than 90% relative density of compaction, then Section 306-1.2 of the Standard Specifications for Public Works Construction and the Special Provisions for the Construction of Sanitary Sewers would apply and note (b) under X would be shown on the plans.

4. Protection and Backfill near Building Sites

Special precautions must be taken for any sewer construction near existing or proposed building sites whether in a fill area or not. The load distribution line will commence at and extend downward at a 45 degree angle from the bottom outside edge of the foundation.

If the sewer pipe is below the 45 degree line, it will be encased per S-23 Case I. Also all backfill below the 45 degree line will be in accordance with note (b) of X.

Special methods must be used by a contractor to insure protection to existing buildings while construction is underway. The locations of such buildings must be precisely shown on the plans. However, the construction methods used will be the contractor's prerogative unless indicated on the plans in special cases.

5. Special Support and Protection

If the filled area in which the sewer is being constructed is found by the required field tests to have a relative density of compaction less than 90%, special design for adequate support and protection of the sewers is essential.

If the relative density of compaction is found to be between 80% and 90%, all main line and house laterals shall be cradled per S-23, Case III or have special base course per S-21, Case III. Special manhole bases per S-14 are also required. If the relative density of compaction is found to be less than 80%, contact the Land Development Division, Road, Sewers and Water Section.

J. SEWAGE PUMP STATIONS

The Engineer should check with the Design Division, telephone 226-8267, before any design work is done on a sewage pump station to determine the type of structure required, and its location. Frequently it is necessary to get a zoning variance, which this office can advise you in obtaining. Building, Electrical and Plumbing permits may be required in addition to the Sewer Construction permit.

However, the applicable permits will be indicated on the plans upon completion of the plan check. When a station is located within a street right of way, the engineer must secure approval of the plans for the structure from the Permit Section of the Construction Division.

K. WATER POLLUTION CONTROL PLANTS AND DISPOSAL FACILITIES

Whenever the need arises for the submission of plans for Water Pollution Control Plants, or other special disposal means for checking, it is mandatory that you contact the Design Division, before any design work is started. A preliminary report covering the exact type of treatment, effluent disposal, location, size, etc., must be submitted and approved by this office, the Los Angeles County Health Department and other regulatory agencies before design work commences.

PART III
FEES AND CHARGES

A. PAYMENTS

All personal checks, cashiers checks, certified checks and money orders for the payment of fees, deposits, charges and permits submitted to this Department are to be made payable to "County of Los Angeles-Department of Public Works." For work within a contract city, payments are made directly to the City.

B. ESTIMATED VALUATION

Whenever the fees are based on valuations, the Department of Public Works will determine the estimated valuation based on approved estimating practices.

C. REFUNDS

When certain fees have been paid and the project is abandoned or cancelled before any work is performed, a refund in the amount of 80% may be authorized. Refer to Section 20.28.070 of Title 20 for further details.

D. REQUIRED FEES

1. Plan checking fees

No plan checking will be performed until the required fee is paid. See Plate No. 1 for a sample plan checking application form.

The plan checking fees are based on the valuation of the project. Refer to Section 20.32.230 of Title 20 for the schedule of fees.

In certain cases, supplemental plan checking fees are required.

2. Reimbursement Charges

Throughout the county, and in some contract cities, several sewer reimbursement districts have been established.

Maps of these districts are maintained by the Land Development Division, Road, Sewers and Water Section, and can be checked for areas involved and connection charges. Such charges may be based on frontage benefit

or acreage, or both, and the total amount due the County will be calculated by the Road, Sewers and Water Section during the plan checking process.

3. Inspection and Record Plan Fees

See Plate No. 2 for a sample Construction Permit Application Form. Unit prices used in computing the valuation of the work are subject to change as conditions warrant. The fees as set forth in Sections 20.32.120 and 20.32.210 of Title 20 are required to cover the cost of field inspection of the proposed construction, preparing record plans, automobile mileage and all overhead and indirect costs. For additional approved work not included in the original permit, an additional fee is required. The Construction Permit will not be issued until a Road Excavation Permit or State Highway Encroachment Permit is obtained, an OSHA Permit from the State of California is obtained and a certificate of Worker's Compensation Insurance is on file with the Department of Public Works, Land Development Division.

Also, the required sets of prints of the plans as outlined in Part V, Section A, must be submitted prior to the issuance of the Construction Permit.

4. Fees for Processing Sewer Easements

For each private contract requiring the processing of sewer easements, a fee is required as set forth in Section 20.32.240 of Title 20. If it is necessary to rewrite the description because of a realignment or revisions, an additional fee is required. See Plate No. 3 for a sample Easement Processing Application Form.

5. Fee for Processing Reimbursement Jobs

For each private contract requiring the processing of reimbursement documents and maps, the fee as specified in Section 20.32.260 of Title 20 in addition to the plan checking fee is required.

6. Fees for Preparing Special Studies

Before proceeding with the preparation of a special area or reimbursement study to serve a specified area, a fee as set forth in Section 20.32.250 of Title 20 is required.

If, after the fee is paid, a change in the study is requested which will increase the cost of doing the work, a supplemental fee shall be collected in the amount of the estimated additional cost. Area studies prepared by others and submitted for checking by the Department of Public Works shall be subject to a fee as specified in Section 20.32.250 of Title 20.

However, there shall be no additional fee collected for the checking of a study required in connection with plan checking for which a fee has been paid under Section 20.32.230 of Title 20.

E. CONNECTION CHARGES

Whenever the sewer plans indicate that house laterals are to be constructed to an existing sewer, and it has been determined that the property did not participate in the cost of the main line sewer, it will then be necessary for the owner of the property to pay a frontage charge to the County.

This charge, as established by the Board of Supervisors and commonly referred to as the "Ordinance Frontage Charge," is specified in Section 20.32.130 of Title 20. The assessable frontage and amount of the charge will be computed by Land Development Division, Road, Sewers and Water Section personnel.

F. SEWER MAINTENANCE CHARGES

Any person who desires to place a newly constructed public sewage system in operation prior to the inclusion of the property benefited in a sewer maintenance district, must pay an annexation and sewer maintenance charge. The amount determined by the Sewer Maintenance Division will cover such cost from the time the sewer is placed in operation until the property is included in a maintenance district and district monies become available to provide for the maintenance and operation of the sewer.

The charge is computed by Sewer Maintenance Division personnel and includes charges for maintaining main line sewers, sewage pumping plants and water pollution control plants. Refer to Section 20.32.280 of Title 20 for the basis of these charges.

G. OTHER CONNECTION CHARGES

1. Sanitation District Charges

There are some instances where a new sewer system must be annexed to a Sanitation District. The necessary papers, petitions and information regarding annexation fees may be obtained at the Sanitation Districts Office. Sewer plans will not be approved until the annexation arrangements have been completed.

2. Other Outlet Agencies

Sanitary sewers in certain portions of Los Angeles County outlet into outfall sewers under the jurisdiction of agencies other than County Sanitation Districts. For information regarding annexation, connection and capacity charges the proper agency should be contacted.

PART IV
PLAN PROCESSING

A. SANITARY SEWER EASEMENTS

All public sanitary sewers must be located either in public rights of way (streets) or easements granted to the County of Los Angeles or contract cities for sanitary sewer purposes. Such easements must be granted to the County by one of the following methods: by dedication on a tract map, or parcel map or by a separate instrument.

The chart found elsewhere in this manual allows information relative to processing the easement under these methods.

Plan Approval

Any easement shown on a sewer plan must be granted to and recorded by the County of Los Angeles before plan approval can be granted. The exception is when an easement is to be dedicated on a tract map or parcel map.

Instructions

Any questions concerning the preparation of legal descriptions and documents and the execution and processing of such documents should be referred to the Land Title Engineer, Valuation/Acquisition Division of the Facilities-Management Department at 738-2421. All correspondence and telephonic communication should refer to the Private Contract sewer number assigned the project.

SANITARY SEWER EASEMENT PROCESSING

STEP	BY SEPARATE INSTRUMENT	WITH A TENTATIVE TRACT & PARCEL MAP
Approval	Obtain approval from Road, Sewers and Water Section of the Land Development Division for location and dimensions of the easement.	Locations of all easements must be approved by Section Head. Easements needed for future sewers may also be required.
Documentation	3 copies of right of way sketch to be submitted to Road, Sewers and Water Section of the Land Development Division. Refer to Plate No. 8. Right of Way Engineering Section of Valuation/Acquisition Division will prepare the easement document.	Easement to be plotted on original Tract or Parcel Map
Title Report	Upon receipt of the sketch from the Engineer the Land Title Section of Valuation/Acquisition Division shall secure an up to date title report on the parcel granting the easement.	Title Report for Tract or Parcel Map Filing is sufficient.
Fees	Fees in accordance with Section 20.32.240 of Title 20 shall be collected.	None.

SANITARY SEWER EASEMENT PROCESSING (Con't.)

STEP	BY SEPARATE INSTRUMENT	WITH A TENTATIVE TRACT & PARCEL MAP
Easement Document Preparation	All necessary documents are prepared by the Right of Way Engineering Section of Valuation/Acquisition Division. These documents are given to the Engineer to obtain the necessary signatures.	No documentation required. Easement shown and labeled on Tract or Parcel Map
Final Conveyance	Executed documents will be recorded by Land Title Section of Valuation/Acquisition Division.	Easement is dedicated when Tract or Parcel Map is filed.

B. LETTER OF PARTICIPATION

Letter of Participation for each private contract must be on file in this office before the sewer plans will be approved.

Refer to Plate No. 5 for a sample Letter of Participation. Copies of these forms will be furnished by the Land Development Division during plan checking.

The letter of participation lists those properties that are participating in the project.

All properties listed will be exempt from any ordinance frontage charges at the time connection to the sewer is made.

The letter of participation should give a brief description of these properties.

1. Suggestion Acceptable Notes

- a. Tract No. 39000.
- b. All property fronting on the sewers.
- c. Tract No. 39000 and all that property on the west side of sewer easement.
- d. Lots 5, 9, 10 and 12, First Subdivision Tract.

- e. That property on the northeast corner of First Street and Second Avenue with 100 feet of frontage on each street.

2. Acceptable Maps

In some cases where it is difficult to describe the parcels participating, it may be acceptable to attach a map to the letter of participation forms. Long legal descriptions only are undesirable.

3. Unacceptable Notes

- a. "1136 Sunshine Lane"
- b. "Bob Jones"
- c. "Robert Smith's property"

4. Signature

A Letter of Participation must be signed by the property owner or owners constructing the sewer project. For a new subdivision, the developer may sign the Letter of Participation. The engineer preparing the plans does not sign this letter unless he is specifically authorized by the property owners. Notarization of the Letter of Participation is not required.

C. OFFER OF DEDICATION

An offer of Dedication must be prepared for all Private Contracts excepting sewers that are built for a new subdivision, or parcel map, or sewers being constructed as private sewers. Refer to Plate No. 6 for a sample Offer of Dedication form.

Three copies are to be signed, notarized and returned to the Road, Sewers and Water Section of the Land Development Division. If the instrument is executed by a corporation or partnership, appropriate notary acknowledgements must be attached and the corporate seal affixed. An Offer of Dedication for a new subdivision or parcel map will be included in the agreement accompanying the bond guaranteeing the construction of sewers or on the signature sheet of the tract map and therefore no separate Offer of Dedication is needed.

Your attention is directed to the statement on the form that sewers are constructed for public use and are offered for dedication. Upon acceptance, the County (or contract city) assumes all further responsibility for the operation and maintenance of the main line sewers.

D. BONDS AND AGREEMENTS

If the installation of sanitary sewers is required as a condition for the filing of a subdivision, the sewers must either be constructed by the subdivider and accepted by the County, or if the required sewers have not been completed, certain bonds must be posted before the tract or parcel map can be filed.

The cost estimates, for the bonds and agreements are prepared by the Sanitary Engineering Section of the Land Development Division at the time of plan checking.

Four copies of the bonds and agreement forms are furnished the subdivider. After execution, one is retained by the surety, one by the subdivider, and the original and one copy are returned to the Subdivision Section of the Land Development Division for transmittal to the Board of Supervisors for acceptance.

If a reimbursement contract is involved, a special agreement form is prepared and the original and three copies of the executed faithful performance bond, the bond for labor and materials and the reimbursement agreement are returned. One completely executed copy of these documents showing County approval is returned to the subdivider.

All the above-mentioned forms are prepared and furnished by the Subdivision Section except the reimbursement agreement forms which are available in the Road, Sewer and Water Section.

Your attention is directed to the fact that clearance for map filing is never given to the Board of Supervisors by the Department of Public Works until the sewer plans are signed and approved by all agencies concerned.

E. ROAD GRADE APPROVAL

All private contract sewer projects prepared for a new subdivision require street grade approval from the Department of Public Works so that adequate depths and locations can be ascertained.

Until approved road plans are received, the sewer plans cannot be given a thorough and final check nor be approved. If only preliminary road grade approval has been granted, it shall be necessary to deepen or lower the mainline sewer to insure a 6-foot connection at the property line.

F. PRELIMINARY PLAN APPROVAL

Preliminary sewer plans may be approved for any subdivision, except as noted below, either in the County or a contract city, for which a bond and agreement is required as a condition for filing of the subdivision.

1. Preliminary Plans Not Acceptable

Final sewer plans for subdivisions must be approved before the final subdivision map is transmitted to the Board of Supervisors for approval and filing, if:

- a. The subdivider applies for reimbursement
- b. Another governmental agency, whose approval of the sewer plans is necessary, will not approve preliminary plans.
- c. Sanitary sewer rights of way are required outside the subdivision. However, if such rights of way are granted to the County by separate document prior to subdivision filing, preliminary plans may be approved.

2. Requirements

Sufficient engineering data must be submitted to demonstrate that:

- a. The design is in accord with the design criteria, Standards and Specifications of the Department of Public Works.
 - b. Final plans will conform to the preliminary plans with only minor changes. The preliminary sewer plans can be submitted at any time after approval of the semi-final tract or parcel map. However, final sewer plans must be approved prior to the issuance of the construction permit.

3. Prints Required

- a. Preliminary plans are to be drawn on standard private contract sewer sheets (linen). For preliminary approval, plans may be in pencil, however, final plans must be in ink.
- b. Two prints of the preliminary plans shall be submitted by the private engineer for checking.

- c. Three sets of prints of the corrected preliminary plans shall be submitted to the Road, Sewers and Water Section for title block stamping and necessary signatures. One approved print will be sent to the Land Development Division, Sanitary Engineering Section, one to the engineer preparing the plans, and one to the outlet agency.

4. Fees Required

- a. Plan check fee in full.
- b. Right of Way processing fee in full.
- c. Maintenance charge.
- d. Reimbursement payments and Ordinance connection charges must be paid when applicable.
- e. All other applicable fees including annexation charges.

5. Documents and Supporting Data Required

- a. Area study.
- b. Right of way clearance if not shown on the tract map.
- c. Water well locations.
- d. Letter of participation.
- e. Approved semi-final tract map or parcel map.

6. Additional Supporting Information Required

The private engineer must submit whatever items listed below are needed as requested by the Road, Sewers and Water Section of the Land Development Division.

- a. Underground letter if sewers are in existing streets.
- b. Field notes.
- c. Grading plans.
- d. Geology report if project is in critical area.
- e. Department of Public Works road requirements and State Highway requirements if special conditions expected. Verbal information and note on check sheet acceptable for preliminary plan.

- f. Test borings if ground water or soil conditions critical to job.
- g. Print of preliminary road grades by private engineer.

7. Approval of Preliminary Plans

- a. The preliminary plans will be approved and signed by:
 - (1) The Registered Civil Engineer preparing the plans.
 - (2) The Land Development Division registered Civil Engineer responsible for checking the project in the Road, Sewers and Water Section.
 - (3) The Assistant Division Engineer of the Land Development Division.
 - (4) County Sanitation Districts or other similar agency involved.
 - (5) Any other governmental agency involved with the sewer system.

G. REIMBURSEMENT PROJECTS

In accordance with Section 15007 of the Education Code and Sections 23010.3 and 50140 of the Government Code of the State of California, the Board of Supervisors will enter into reimbursement agreements with individuals, corporations, school districts or subdividers for the construction of sewerage facilities that are constructed to serve or benefit additional areas other than the property of the owner constructing the sewer. Payment may be on a long term "deferred basis" or immediate "lump sum."

Generally the steps involved in the processing of a Reimbursement Project are as follows:

- 1. A comprehensive area study must be prepared. This may be done by the Engineer or it will be prepared by the Land Development Division upon receipt of the special study fee.
- 2. The reimbursement processing fee must be submitted. This is to provide for the preparation of all agreements, maps, reimbursement calculations, etc.
- 3. The sewer plans must be completed before final processing can be accomplished.

4. An agreement will be prepared by the Department of Public Works setting forth the maximum amount of reimbursement or an amount equal to a certain percentage of the total cost necessarily incurred in constructing the main line sewer, whichever is the smaller, and also setting forth the terms and conditions under which reimbursement will be paid.
5. After the agreement has been entered into, a Notice Inviting Bids must be published at least once in the "Dodge Construction News-Green Sheet Edition" or in the Daily Construction Service publication. The notice must be approved by the Department of Public Works Department before publishing. Publication must be made at least 7 days prior to the date for opening of bids.
6. Proposal or bid forms must also be submitted to the Department of Public Works for approval before being given to the prospective contractors.
7. Bids submitted by contractors must be accompanied by bid bonds made out to the developer for at least 10% of the total bid price.
8. Sealed bids must be presented at the office of the Department of Public Works on or before the time specified in the Notice Inviting Bids.

An exception to this is that on school district reimbursement projects, bids may be opened in their offices.

9. Bids will be opened by the Department of Public Works immediately following the time specified in the Notice in the presence of the contractors and any other persons interested in the project.
10. After the bids have been analyzed, the successful bidder will be designated and by written notice the developer will be authorized to enter into a contract for the proposed work. It is mandatory that a contract be entered into with the successful bidder.
11. Upon completion of the construction, receipted bills for the cost of all work relating to the sewer and an Affidavit of Publication must be submitted in triplicate to the Road, Sewers and Water Section of the Land Development Division. The Land Development Division will request these bills and set forth the acceptable form.
12. The Department of Public Works will prepare a claim which, if satisfactory to the subdivider, must be signed by the same persons or corporation who signed the Agreement. If new owners have acquired the property between the time the contract is signed and

the claim for payment is made, authority to pay the new owner in the form of an assignment must be submitted in triplicate. The signatures of individuals and partnerships shall be duly notarized and corporation signatures shall bear the corporation acknowledgement. The signed claim, in triplicate, is to be returned to the Land Development Division. Upon acceptance of the sewers by the Board of Supervisors, the claim will be forwarded to the County Auditor for payment.

13. If the claim is in order, payment will be made in about ten days if lump sum payment was stipulated in the reimbursement agreement. Otherwise payment shall be made as stipulated in the agreement.

H. SPECIAL STUDIES

Quite often it is necessary for an engineer or subdivider to request the Land Development Division to make a special study so that they can determine certain information before they begin the design of a sewer.

These studies may include area studies to determine the most feasible outlet and required pipe sizes; reimbursement studies to determine eligibility and approximate amount of reimbursement and cost to the subdivider; preliminary treatment plant layouts; and other difficult problems.

All such studies will require the Special Study Fee before any work can be started. (Refer to Part III, D-6 for information on fees for Special Studies).

PART V
PROJECT COMPLETION

A. REQUIRED PRINTS OF APPROVED PLANS

The construction permit will not be issued on any private contract sewer project until the approved tracings and prints have been received and distributed as follows:

1. Road, Sewers and Water Section of the Land Development Division (Room 605).

Each Sheet	Original tracing 6 Black and White Prints 1 Van Dyke Negative or reproducible brown line
------------	---

Index Map	Original tracing 25 Black and White Prints
-----------	---

2. Construction Division, Room 114, 1540 Alcazar Street, Los Angeles, California 90033, (213) 226-8195.

Each Sheet 4 Black and White Prints

Item "2" applies when a Road Excavation Permit is required for excavation in a public street or highway. The road permit must be obtained before the Sewer Construction Permit will be issued.

The number of prints listed above does not include prints for state encroachment permits, the sewer contractor, the engineer, or the subdivider.

Each approved plan revision will usually necessitate making a new distribution of prints of the pages revised.

B. PERMITS

1. Construction Permit

This permit covers the charges incurred in inspecting the project while being constructed and the preparation of "as-built" plans.

Before this permit can be issued, the following items must be completed:

- a. Plan approval by all agencies concerned.
- b. Distribution of prints as enumerated in the preceding section.
- c. Obtain Road Excavation Permit and/or State Encroachment Permit if required.
- d. Obtain permit to excavate trenches from the State of California, Division of Industrial Safety.
- e. Obtain a Certificate of Worker's Compensation Insurance with the Department of Public Works, 550 South Vermont, Los Angeles, California 90020, named as the certificate holder to be notified 30 days prior to cancellation of policy.
- f. Complete "Construction Permit Application" and pay fee. If project is located within a contract city fee should be deposited with the City.

The Construction Division, Construction Inspection Section, must be given 24-hour notice before construction is to start so that an inspector can be assigned.

2. Provisional Approval for House Connections

The granting of a provisional permit for a new subdivision authorizes the Building and Safety Division to issue connection permits before construction is entirely completed. However, the subdivider assumes the responsibility for operation and maintenance of the main line sewer. No provisional permit will be issued for "non tract" jobs.

The "95%" completion notice (Refer to Plate No. 9) sent to the subdivider or developer by the Construction Division actually constitutes underground approval of the sewers. Normally, the only work remaining to be done is the new street paving and adjusting of manhole frames and covers.

The request for provisional permits is submitted in quadruplicate on the subdivider's letterhead and should be similar to Plate No. 10. A waiver similar to Plate No. 11 signed by the contractor must also be submitted. Sanitation Districts or other agencies responsible for the final treatment of sewage must grant approval of the project before provisional permits may be issued.

There is no charge for the approval of requests for provisional permits.

3. House Lateral Extension

In some instances, the subdivider wishes to extend the house sewers into the lots to a point 5 feet from the house plumbing outlets while construction of the main line sewer is in progress. If the sample letter shown on Plate No. 12 is submitted to the CONstruction Division prior to final clearance, it will be reviewed and considered for approval. In no case will approval be given unless the letter of request is submitted.

In most cases, these requests will be for new tracts. However, in some particular cases, approval may be given on private contracts other than subdivisions. It is recommended that the main line sewer contractor also put in the extensions. If a second contractor is going to construct the extensions, then the following procedure is required (Refer to Plate No. 12-A): Letters must be submitted by the main line sewer contractor and the permit applicant giving permission for the second contractor to connect to the house laterals before final clearance is given by the CONstruction Inspection Section of the Construction Division. A cleaning deposit and a Construction-Inspection fee must be submitted by the second contractor. The cleaning deposit will be placed in trust and will be refunded if the sewers are cleaned and left in a condition acceptable to the County.

4. Temporary Sewage Disposal

a. Temporary cesspools.

If the sewer system is being constructed in conjunction with a new subdivision, then normally permission for temporary facilities could be given after the Bond of Faithful Performance and Labor and Material Bond is accepted by the Board of Supervisors. Extreme care must be taken to guarantee that all temporary facilities are abandoned and the houses are connected to the new sewer prior to release of the bond. Contact the Construction Division for necessary letters and clearances in all such cases.

b. Tank trucking.

If it is certain that outlet facilities will be available in two to four weeks, requests for tank trucking of sewage from the new system will be considered by the Department of Public Works. A fee to cover inspection and compliance with requirements must be paid if such a request is granted. CONTACT the Land Development Division for necessary letters and clearances in all such cases.

C. GRADE SHEETS

The County Engineer Standard Sewer Grade Sheets were initiated to standardize the forms on which the private engineer must compile and furnish the necessary construction data to the Construction Division inspector assigned to the project. These grade sheets are setup so that one sheet should be used for each page of plans.

Any questions regarding the use of these forms should be directed to the Construction Division.

A sample grade sheet is shown on Standard Chart S-C2.

D. CHANGE OF PLANS

The procedures listed below are to be followed when a change is desired on any portion of the sewer plans of a private contract.

1. After Plans have Been Checked but Prior to Approval

A fee as specified in Section 20.32.230 of Title 20 shall be paid for any additional work which increases the total valuation.

2. After Plans Approved

a. Letter of Request.

A Letter of Request must be submitted by the private engineer giving adequate information and reasons for the requested plan change. This letter should be directed to the Land Development Division, Road, Sewers and Water Section.

b. Supplemental Fees.

A fee as specified in Section 20.32.230 of Title 20 shall be paid for any additional work which increases the total valuation.

If the construction permit as been issued, a supplemental construction inspection fee will also be required if additional sewer lines or facilities have been added.

c. Revision Approval Box.

A revision box shall be provided on the title page giving a brief but complete description of the revisions. This box shall be prepared as shown below.

REVISION NO. _____ DATE _____
Description of revision in full including page number and stationing involved.
APPROVED _____ Department of Public Works/R.E. No. _____

In some major changes, the signatures of the Assistant Division Engineer of the Land Development Division and the outlet agency Chief Engineer may be required in the above revision box.

d. Revised Prints.

Any revision will require that a complete distribution of new prints be made (refer to Part V, Section A).

A new set of Index Maps will also be required if the revisions affect main line sewer or manhole locations.

e. Rights of Way.

If the plan change involves acquisition of additional sewer easements, the physical construction of any improvements within such easements will not be permitted until the right of way has been granted to the County.

E. AS-BUILT PLANS

The Record (as-built) Plans are prepared by the Land Development Division. All information regarding the sewer construction, as noted by the Construction Division, Construction Inspection Section, is shown on the original tracings of the plan.

A template number is assigned to each page for filing purposes. Upon completion of a sewer project this tracing becomes a permanent public record and is filed in a vault for safekeeping.

Record plans will not be released for placement into the Building and Safety Division District Office permit books for house connection permit issuance until all necessary clearances have been obtained.

Charges for the preparation of record plans are included in the construction permit fee.

APPLICATION FOR PLAN CHECK SERVICES
 COUNTY OF LOS ANGELES
 DEPARTMENT OF PUBLIC WORKS
 LAND DEVELOPMENT DIVISION

Date _____ D.N. # _____
 TR./PM. No. _____
 Non-Subdiv. Proj. Addr. _____
 City _____ Location _____

Applicant/Fee Payer _____ Tel. No. () _____
 Address _____ City _____ Zip _____
 Engineer/Fee Payer _____ Tel. No. () _____
 Address _____ City _____ Zip _____

	SUBDIVISION - Map Analysis	- Actual	- I/S \$	F
	9214 - PM's - Easement Checking	- Actual	- I/S \$	F
	9215 - TR's - Monument Checking	- Actual	- I/S \$	F
	- Verif. of Conditions	- Actual	- I/S \$	F
	- Tax Clearance Proc.	- Actual	- I/S \$	F
	- Tax Bond Proc.	- Actual	- I/S \$	F
	- Agreement/Improvmnt Security	- Actual	- I/S \$	F
	- Resubmittal (4th, 6th, 8th)	- Actual	- I/S \$	F
	- Overtime - J.N.	- \$700.PM/\$1000.TR	- I/S \$	D
I.	ROAD - Street Plans	- 75% of Est. Fee	- I/S \$	F
	- Inspection	- Actual	- I/S \$	D
II.	F.P.M.-0540 - J.N. - P.D.	- \$500.00	- I/S \$	F/D
V.	F.C.D. - P.D./M.T.D./F.M.	- \$ 75.00	- I/S \$	F/D
	- Flood Hazard Report	- \$ 30.00	- I/S \$	F
	SEWER-9526 - J.N. - P.C.	- 75% of Est. Fee	- I/S \$	F
I.	WATER-9229 - J.N. 0250.10	- \$75.00/75% of Est. Fee	- I/S \$	F/D
	ILLING/RECORD-0401-		- I/S \$	F
	- San. Sewer Procedural Manual \$15.02 + \$.98 Tax		- I/S \$	F
	ther		- I/S \$	F/D

D.M.A. SURCHARGES:
 + II. _____ + III. _____ + V. _____ + VI. _____ + OTHER _____ = \$ _____ F

SUBDIVISION VERIFICATION DEPOSIT:
 .N. _____ GRDG. _____ +GEOL. _____ +II. _____ +III. _____ +V. _____ +VI. _____ = \$ _____ D

NOTES: 1. I = Initial, S = Supplemental, F= Fee and D = Deposit
 2. Further deposit will be required if actual costs exceed the above amounts.

Cashier _____ Check No. _____ TOTAL: \$ _____
 Signature _____

Original - Land Dev. Div.
 Copy - Cashier
 Copy - Control/LDMA
 Copy - Fee Payer
 Processed by _____ No. **02231**
 /19/85

APPLICATION FOR CONSTRUCTION PERMIT

ENVIRONMENTAL DEVELOPMENT DIVISION
DEPARTMENT OF COUNTY ENGINEER FACILITIES
COUNTY OF LOS ANGELES

Rd. Permit _____

OSHA _____

Work. Comp. _____

Date _____

P.C. No. _____

J.N. _____

Applicant _____ Address _____

City _____ Tele. No. () _____

Name of Project _____ Region _____

Location _____ Thomas Guide Pg. _____

Contractor _____ Address _____

City _____ Tele. No. () _____

Signature of Applicant or Authorized Agent _____

Note: The Contractor shall notify prior to 9:00 A.M.,

Mr. _____, Head Constr. Insp. _____ Region,

Telephone Number _____, 24 hours before starting work under this permit.

DESCRIPTION OF WORK	VALUATION	FEE
I. CONSTRUCTION-INSPECTION AND RECORD PLANS:		
Mainline and House Lateral Sewers	\$ _____	
Sewage Pump Station and Force Main	_____	
Treatment and Disposal Facilities	_____	
Others _____	_____	
TOTAL	\$ _____	\$ _____
II. SUPPLEMENTAL — Construction-Inspection and Record Plans		
	\$ _____	\$ _____
III. L.D.M.A. FEE _____		
		\$ _____
IV. MISCELLANEOUS _____		
		\$ _____
		TOTAL PERMIT FEE \$ _____

STEPHEN J. KOONGE, County Engineer

VALIDATION

By _____ Office No. _____

- White — Env. Dev. Div.
- Canary — Applicant
- Pink — Cashier
- Green — Construction Sect.
- Goldenrod — LDMA

PLATE NO. 2

APPLICATION FOR SEWER EASEMENT PROCESSING

ENVIRONMENTAL DEVELOPMENT DIVISION
DEPARTMENT OF COUNTY ENGINEER FACILITIES
COUNTY OF LOS ANGELES

Date _____
P.C. No. _____
J.N. _____

Applicant _____ Address _____

City _____ Tele. No. _____

Name of Project _____

Location _____ Thomas Guide Pg. _____

Engineer _____ Address _____

City _____ Tele. No. _____

Signature of Applicant or Authorized Agent _____

DESCRIPTION OF WORK

FEE

Easement Processing or Vacation Processing Fee:

First Application Supplemental Application

Rates: First Parcel _____ each Additional _____

Number of Parcels this Application _____ \$ _____

Additional Information:

~~STEPHEN J. KOONCE, County Engineer~~

TOTAL FEE \$ _____

By _____ Office No. _____

VALIDATION

- White - Env. Dev. Div.
- Canary - Applicant
- Pink - Bus. Mgm't. Div.
- Green - Real Prop. Val. & Pl. Div.

Application For Sewer Maintenance

SEWER MAINTENANCE DIVISION
DEPARTMENT OF PUBLIC WORKS
COUNTY OF LOS ANGELES

Date _____

P.C. _____

Applicant _____ Address _____

City _____ Telephone No. _____

Name of Project _____

Location _____ Thomas Guide Pg. _____

The above listed applicant hereby applies for immediate maintenance and operation of the sewerage facilities upon acceptance by the County of Los Angeles in accordance with Section 20.32.280 of Los Angeles County Code.

(CHECK ONE BOX)

- This fee is to be deposited in the Consolidated Sewer Maintenance District Fund.
- This charge is to be placed in the Engineer's Trust Fund and may be expended for the purposes intended until the Sewer Maintenance District is formed. Any amounts remaining are to be transferred to the appropriate Maintenance District when formed.
- This donation, for area within the City of _____ is to be placed in the Engineer's Trust Fund to be later transferred to the _____ Sewer Maintenance District.
- _____

T.A. TIDEMANSON, DIRECTOR OF PUBLIC WORKS

TOTAL FEE \$ _____

By _____ Office No. _____

VALIDATION

White - Sewer Maintenance Division
Yellow - Applicant
Pink - Bus. and Finance Division
Green - Land Development Division

LETTER OF PARTICIPATION

Date _____

Director of Public Works
550 South Vermont Avenue
Los Angeles, California 90020

Private Contract _____

Tract No. _____

Dear Sir:

The following is a full and complete list of all abutting properties which have contributed to the cost of construction of the sewer system constructed under Private Contract No. _____:

(Notarization not required)

(Signature)

NOTE: Properties connecting to public sewers constructed at no cost to the abutting property may be made subject to charges as prescribed by Sections 20.32.130, 20.32.140, 20.32.150 of the Los Angeles County Code as amended.

OFFER OF DEDICATION

Honorable Board of Supervisors
County of Los Angeles
California

We hereby declare that the sanitary sewers and appurtenant structures constructed under Private Contract No. in accordance with the plans filed in the Office of the Department of Public Works are built for public use and that upon their acceptance by the County of Los Angeles, all right, title, and interest of the undersigned in and to said sewers shall vest in said County.

(Corporate Seal)

(print name under each signature)

Subscribed and acknowledged to before
me this _____ day of
_____, 19____.

Notary Public in and for the County
of Los Angeles, State of California

NOTE: If the above instrument is executed by a corporation or partnership, appropriate notary acknowledgments are to be attached.

JMC101

PC-5 2-54
Rev. 10-85

8 1/2"

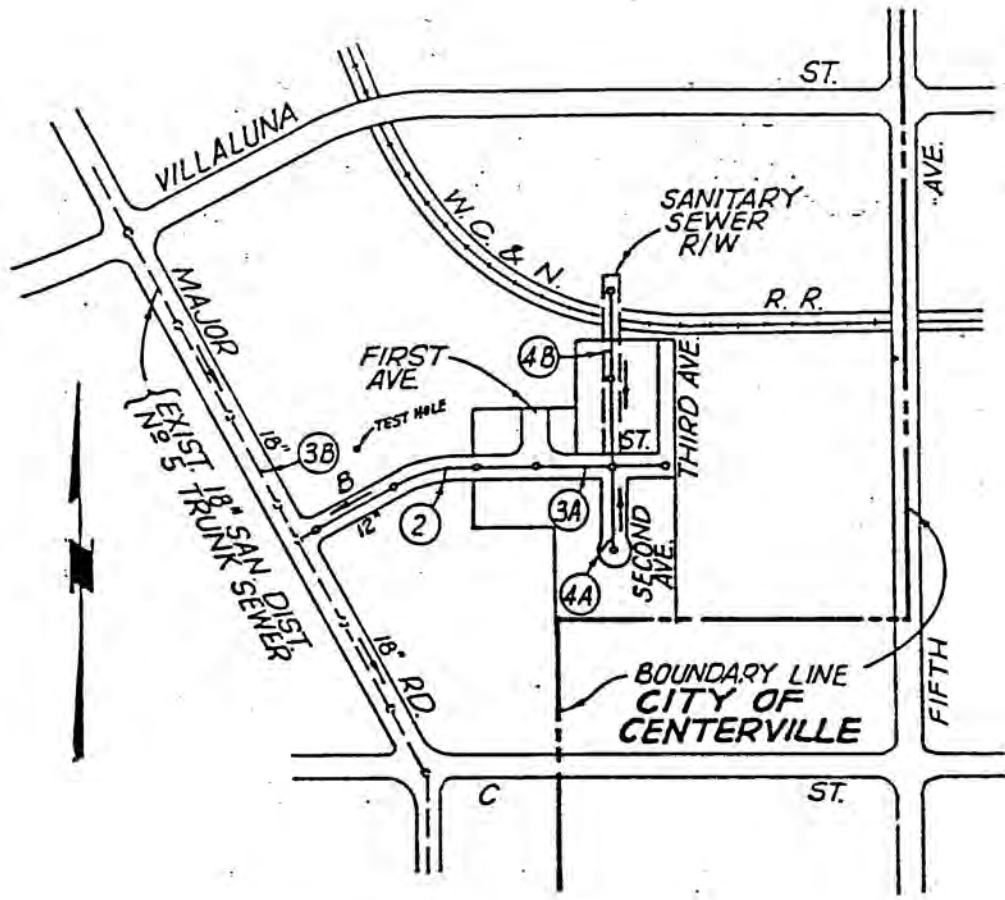

1"

11"

NOTES

NUMBERS IN CIRCLES INDICATE PAGE NUMBERS

SHOW NEAREST MAJOR STREETS
USE 8 1/2" x 11" VELLUM

1/4"

INDEX MAP
(NAME OF JOB)

P.C. _____

T.G. _____

SCALE: 1" = 600'

APPROVED:

T. A. TIDEMANSON
DIRECTOR - DEPT. OF P.W.

by _____ Date _____

R.E. No _____

DEPARTMENT OF PUBLIC WORKS

PROPOSED SANITARY SEWER
EASEMENT IN BLOCK-2
CROWN TRACT
M. R. 37:56

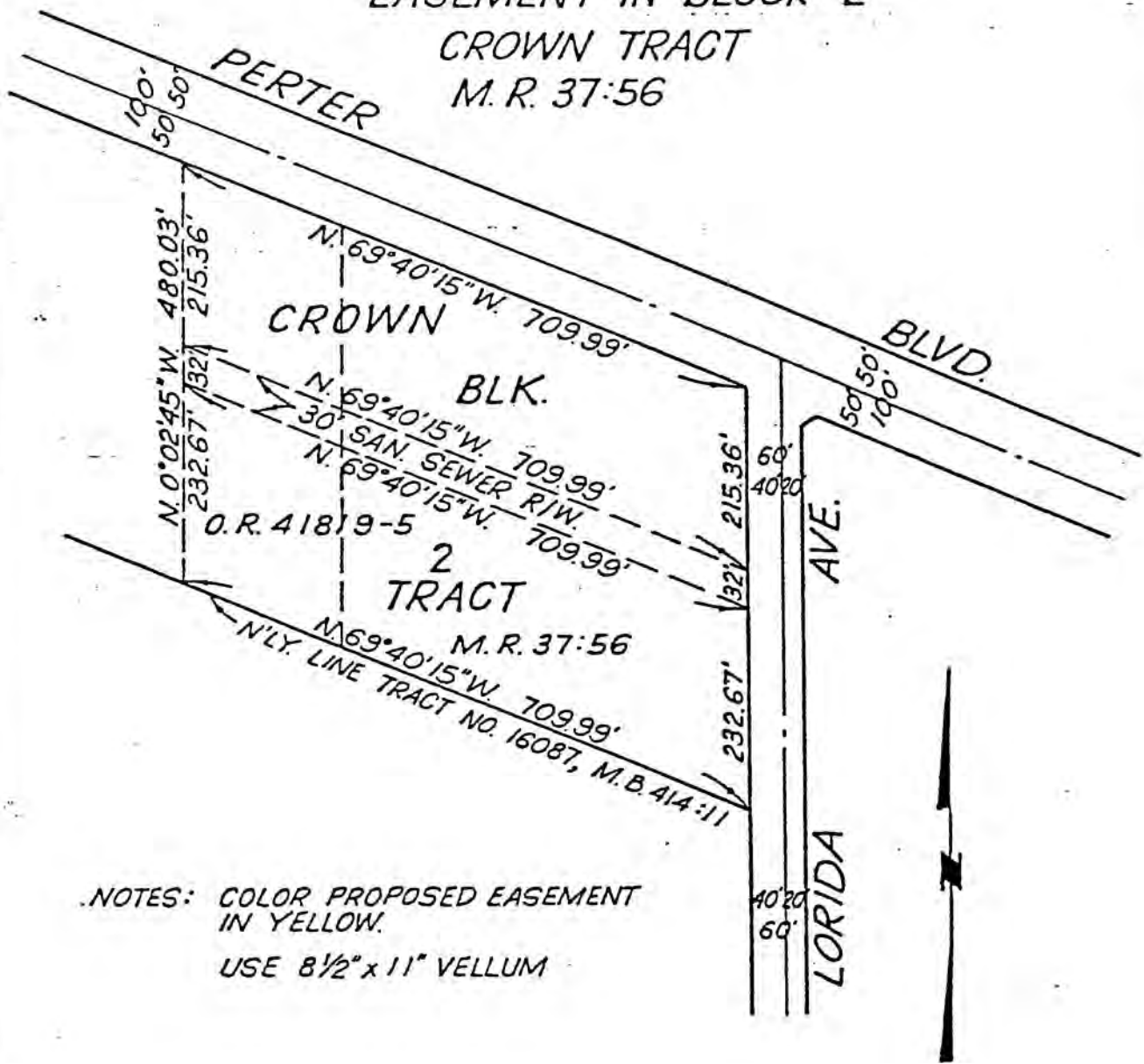

NOTES: COLOR PROPOSED EASEMENT
IN YELLOW.
USE 8 1/2" x 11" VELLUM

P.C. No. _____
W.S. _____
SCALE: 1" = 200'

(LETTERHEAD)

--SAMPLE--
95% COMPLETION LETTER

This letter sent to permittee,
copy to Central Office.

For your information, construction of the sanitary sewers on the above captioned project has been completed, cleaned, and tested, except for the work described below.

The work which remains to be done consists essentially of adjusting the manholes to finished pavement grade and the removal of sand traps in all outlets; this work cannot be accomplished until the paving is completed.

When the paving is completed, notify this office, telephone 213-226-8281, so that arrangements can be made for a final inspection. You must be represented at this inspection by someone capable of removing and/or replacing sand traps. This inspection will be made to ascertain that manholes have been adjusted properly and that sewer lines are clean.

Provisional permits to connect houses to the sewer may be issued provided the subdivider, by letter, accepts responsibility for cleaning and maintaining the sewer until all work is completed and accepted. The letter (four copies) should agree in form to the attached sample.

Also, four copies of the attached waiver form are required.

Very truly yours,

T. A. TIDEMANSON
Director of Public Works

Supervising Civil Engineer III
Contract Administration &
Construction Division

Attachment

JMC85

Rev. 10-85

SAMPLE LETTER
(Subdivider's Letterhead)

(If in a contract City,
change the words
"Director of Public Works"
to "City Engineer").

Mr. T. A. Tidemanson
Director of Public Works

Attention: Mr. C. Rubenacker

REQUEST FOR PROVISIONAL HOUSE CONNECTION PERMITS
SEWERS IN TRACT NO. _____
PRIVATE CONTRACT NO. _____

Permission is requested to connect the houses on Lots _____
of Tract No. _____ to the main-
line sewer constructed under Private Contract No. _____. The
certificate of partial acceptance pending manhole adjustments and cleaning
was issued by the Director of Public Works on _____.

Until such time as the streets have been paved, the manholes adjusted to
finished street grade, and the sewer cleaned, inspected and found
satisfactory by the Director of Public Works, we will assume all responsibility
for the protection and maintenance of the sewers and appurtenances.

We will install three 4" by 4" posts, eight feet long, set three feet into
the ground around the perimeter of all manholes in areas where construction
equipment travels or operates, such posts to be maintained in place until
the start of final paving operations; or as an alternative to the posts
described above, we will protect the manhole against physical damage by
equipment and will install close-fitting covers of plywood completely
covering the manhole channel and shelf so that dirt or other material cannot
enter the sewer.

Under the supervision of the Director of Public Works, we will install sand traps
per Standard Plan S-20 in the first manhole upstream from any operating sewer
in such manner that no dirt, sand, or other debris can be washed into, or
enter the existing sewers in operation.

We will maintain in place, the sand traps and any channel covers until the
final paving is in place and manhole frames have been adjusted to grade, and
remove such sand traps and channel covers after final inspection by and in
the presence of the Director of Public Works.

Mr. T. A. Tidemanson
Director of Public Works

Date _____
Page 2

Also, we will seal the tops of all manholes subject to drainage infiltration in a watertight manner satisfactory to the Director of Public Works. Such watertight sealing will be maintained in effect until final paving of the immediate area.

It is our understanding that if this request is approved by the Director of Public Works, provisional house connection permits will be issued, and upon final acceptance of the sewers, these permits will be considered permanent.

Attached is a signed waiver from our sewer contractor approving the use of the sewer.

Name of Subdivider

Signature of Subdivider
or Authorized Representative

APPROVED: T. A. Tidemanson
Director of Public Works

By _____ Date _____
Subdivision Inspection
Construction Division

CR:mbw
Attachment - 1

PLATE IOA

HOUSE CONNECTION WAIVER

Private Contract No. _____

Tract or Parcel Map No. _____

County of Los Angeles
Department of Public Works

Date _____

I am the contractor for the above described sewer project, which is now under construction. I hereby approve the issuance by the County of Los Angeles of house connection permits to connect to the sewer prior to acceptance.

Name of Contractor

Address

By _____
Authorized Agent

SAMPLE LETTER

(Subdivider's Letterhead)

Date

Mr. T. A. Tidemanson
Director of Public Works

Attention Mr. C. Rubenacker

Dear Sir:

FOUR-INCH HOUSE LATERAL EXTENSIONS
P. C. NO. _____ TRACT NO. _____
VICINITY OF _____

We request permission to extend the sanitary sewer house laterals at the time the main line sewer is laid under Private Contract No. _____ to a point within five feet of the houses in the above numbered tract.

Our engineer will set stakes in each case at the point where the house lateral ends.

I understand that this work must be done concurrently with the main line construction.

No final hookups will be made to the house sewers until permits have been obtained from the Division of Building and Safety, and inspection and approval obtained on each such final hookup.

Our Contractor is _____, _____
(Name) (Address)

_____, California.

Lots No. _____, to _____ are to be connected in this manner.

Yours very truly,

Subdivider

cc: (2)

Rev. 10-85

SAMPLE LETTER

(Subdivider's Letterhead)

Date

Mr. T. A. Tidemanson
Director of Public Works

Attention Mr. C. Rubenacker

Dear Sir:

4-INCH HOUSE LATERAL EXTENSIONS
P. C. NO. _____ TRACT NO. _____
BUILDING DISTRICT OFFICE NO. _____

We request permission to extend the sanitary sewer house laterals laid under Private Contract No. _____ to a point within five feet of the houses in the above numbered tract.

Our engineer will set stakes in each case at the point where the house lateral ends, except in those cases where the location of the plumbing outlet is clearly evident.

No final hookups will be made to the house sewers until permits have been obtained from the Division of Building and Safety, and inspection and approval have been obtained on each such final hookup.

We understand that an amount sufficient to cover the estimated cost of special inspection of the work must be deposited in trust with the Department of Public Works before work can be started.

Our Contractor is _____, _____
(Name) (Address)

_____, California.

Lots No. _____ to _____ are to be connected in this manner.

Yours very truly,

Subdivider

Rev. 10-85

T. A. Tidemanson, Director of Public Works

Attention: Mr. Brian D. Hooper

Date _____

Dear Sir:

PRIVATE CONTRACT NO. _____

SEWER IN _____

VICINITY _____

I have checked with the agencies having jurisdiction over the dedicated roadways, (Los Angeles County Department of Public Works and/or State Division of Highways), and they have approved the location of the proposed sewers.

I have made a search of the available records as well as a physical inspection of the site and all water wells found within 200 feet of the sewers, if any, are shown on the plans.

In compliance with Section 20.32.550 of the Los Angeles County Code I have checked and determined from the following utility or other companies having easements or substructures in the affected area, that the location and size of such structures, as shown on the submitted plans are the same as shown upon such company's record and to the best of my knowledge there is no interference with the proposed sewers.

REG. C.E. NO. _____

JMC100

PC-11 Rev. 10-85

PRIVATE CONTRACT NO.

W. I. _____
CITY OF _____
IN THE COUNTY OF _____

COUNTY OF LOS ANGELES, CALIFORNIA

GENERAL NOTES:
1. CONTRACTOR SHALL BE RESPONSIBLE FOR OBTAINING ALL NECESSARY PERMITS AND APPROVALS FROM THE CITY AND COUNTY ENGINEERS.
2. CONTRACTOR SHALL MAINTAIN ACCESS TO ALL ADJACENT PROPERTIES AT ALL TIMES.
3. ALL WORK SHALL BE COMPLETED WITHIN THE SPECIFIED TIME FRAME.
4. CONTRACTOR SHALL BE RESPONSIBLE FOR PROTECTING ALL EXISTING UTILITIES AND STRUCTURES.
5. ALL MATERIALS AND METHODS SHALL BE APPROVED BY THE CITY AND COUNTY ENGINEERS.
6. CONTRACTOR SHALL MAINTAIN A NEAT AND ORDERLY WORK SITE AT ALL TIMES.
7. ALL EXCESS MATERIALS SHALL BE REMOVED FROM THE SITE.
8. CONTRACTOR SHALL BE RESPONSIBLE FOR THE PROTECTION OF ALL ADJACENT PROPERTIES.
9. ALL WORK SHALL BE COMPLETED WITHIN THE SPECIFIED TIME FRAME.
10. CONTRACTOR SHALL BE RESPONSIBLE FOR OBTAINING ALL NECESSARY PERMITS AND APPROVALS FROM THE CITY AND COUNTY ENGINEERS.

CONSTRUCTION NOTES:

1. ALL WORK SHALL BE COMPLETED WITHIN THE SPECIFIED TIME FRAME.
2. CONTRACTOR SHALL BE RESPONSIBLE FOR OBTAINING ALL NECESSARY PERMITS AND APPROVALS FROM THE CITY AND COUNTY ENGINEERS.
3. CONTRACTOR SHALL MAINTAIN ACCESS TO ALL ADJACENT PROPERTIES AT ALL TIMES.
4. ALL MATERIALS AND METHODS SHALL BE APPROVED BY THE CITY AND COUNTY ENGINEERS.
5. CONTRACTOR SHALL MAINTAIN A NEAT AND ORDERLY WORK SITE AT ALL TIMES.
6. ALL EXCESS MATERIALS SHALL BE REMOVED FROM THE SITE.
7. CONTRACTOR SHALL BE RESPONSIBLE FOR THE PROTECTION OF ALL ADJACENT PROPERTIES.
8. ALL WORK SHALL BE COMPLETED WITHIN THE SPECIFIED TIME FRAME.
9. CONTRACTOR SHALL BE RESPONSIBLE FOR OBTAINING ALL NECESSARY PERMITS AND APPROVALS FROM THE CITY AND COUNTY ENGINEERS.

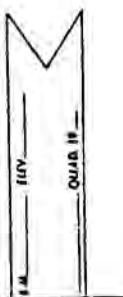

SEE SAMPLE PLAN
(ENCLOSURE)
PLANS TO BE PREPARED
BY ENGINEER

Table with multiple columns and rows, containing technical specifications and data for the sanitary sewer project. The text is dense and appears to be a continuation of the contract details.

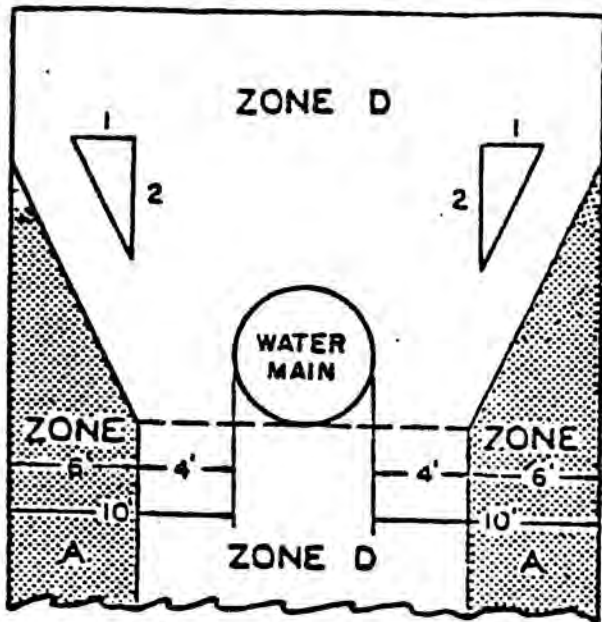

PARALLEL CONSTRUCTION

IF A MAIN LINE SEWER CANNOT BE LOCATED TEN OR MORE FEET FROM A PRESSURE WATER MAIN B MUST BE LOCATED WITHIN ANY OF THE ABOVE INDICATED ZONES, SPECIAL CONSTRUCTION WILL BE REQUIRED AS SHOWN BELOW

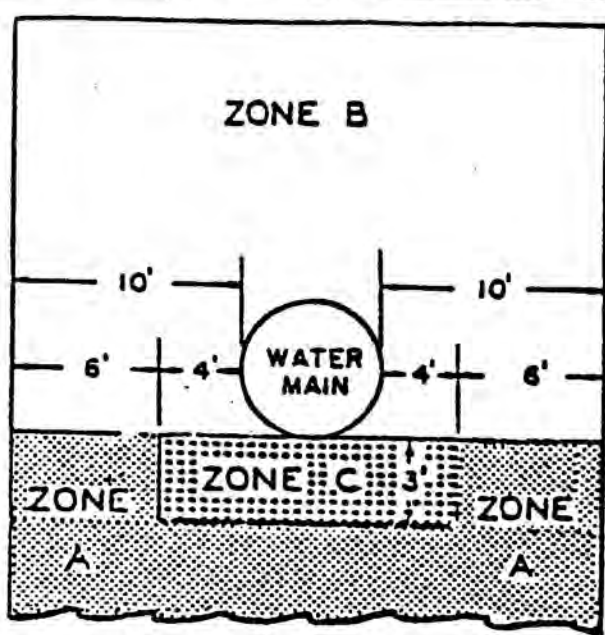

PERPENDICULAR CONSTRUCTION

IF A MAIN LINE SEWER MUST CROSS A PRESSURE WATER MAIN WITHIN ANY OF THE ABOVE INDICATED ZONES, OR IF A HOUSE LATERAL MUST CROSS IN ZONE B, SPECIAL CONSTRUCTION WILL BE REQUIRED AS SHOWN BELOW

ZONE	SEWER CONSTRUCTION REQUIREMENTS
A	V.C.P. WITH MECHANICAL COMPRESSION JOINTS.
B or C	C.I.P. WITH LEAD OR APPROVED MECHANICAL JOINTS; OR V.C.P. WITH SPECIAL CONCRETE ENCASEMENT PER (S-23 CASE III); OR V.C.P. GROUTED IN CONTINUOUS STEEL CASING.
D	DO NOT LOCATE ANY PARALLEL SEWER IN THIS AREA WITHOUT HEALTH DEPARTMENT APPROVAL.

FORCE MAINS:

PARALLEL CONSTRUCTION NOT PERMITTED IN ANY ZONE

PERPENDICULAR CONSTRUCTION IN ANY ZONE REQUIRES C.I.P. WITH LEAD OR APPROVED MECHANICAL JOINTS; OR ASBESTOS CEMENT PIPE WITH SPECIAL CONCRETE ENCASEMENT PER (S-23 CASE III).

THESE CRITERIA WERE ESTABLISHED BY THE LOS ANGELES COUNTY HEALTH DEPARTMENT, IN ACCORDANCE WITH SECTION 542 OF THE HEALTH CODE ORDINANCE 7583.

DESIGN REQUIREMENTS FOR SANITARY SEWERS IN THE VICINITY OF PRESSURE WATER MAINS

COUNTY OF LOS ANGELES
DEPARTMENT OF PUBLIC WORKS

COUNTY ENGINEER
STANDARD

S-CI

DATE: 3/80

DESIGN

RCE

16443

[Signature]
ASSISTANT DEPUTY

[Signature]
COUNTY ENGINEER

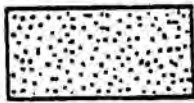

Sand

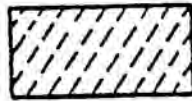

Silt

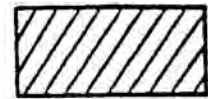

Clay

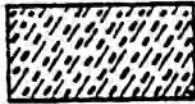

Silty Sand
or
Sandy Silt

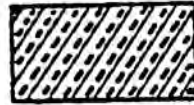

Sandy Clay
or
Clayey Sand

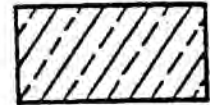

Silty Clay
or
Clayey Silt



Gravel

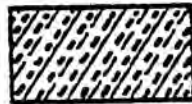

Sandy Silty Clay
Silty Clayey Sand
Clayey Sandy Silty

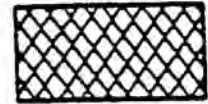

Muck
and / or
Peat

NOTES: Soil types other than those shown above will be identified by description, not by symbols.
Soil type identification is made by field inspection of test hole samples taken to a minimum depth of at least two feet below the invert of the proposed sewer.

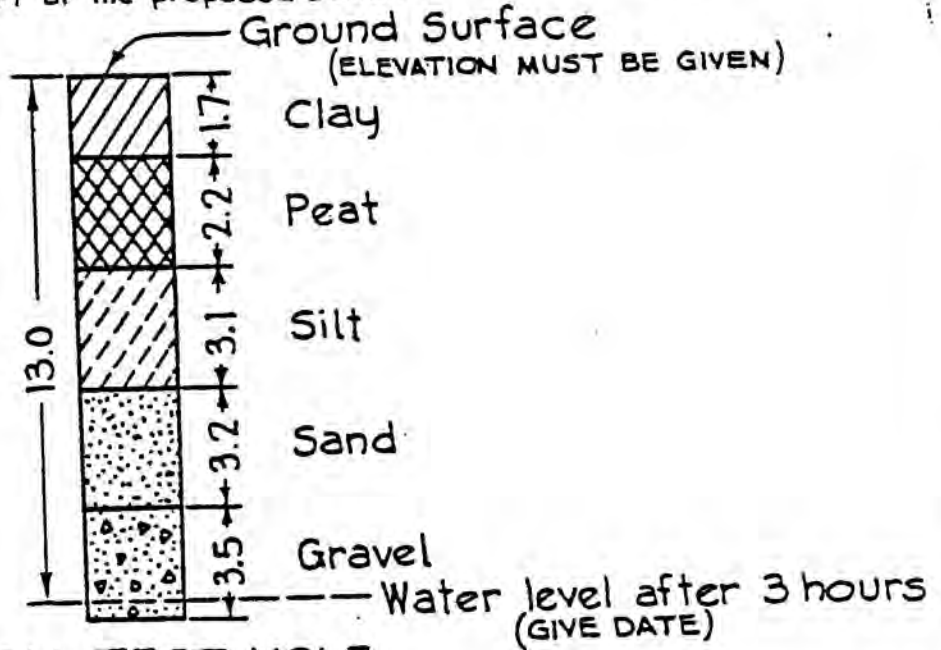

TYPICAL TEST HOLE
(SHOW LOCATION)

STANDARD SOIL SYMBOLS

COUNTY OF LOS ANGELES
DEPARTMENT OF PUBLIC WORKS

[Signature]
ASSISTANT DEPUTY

[Signature]
COUNTY ENGINEER

COUNTY ENGINEER
STANDARD

DATE: 3/80

DESIGN

S-C3

[Signature] RCE
10443

AREA IN ACRES

Single Family Residential	Commercial	Heavy Industrial
2000	533	450
1750		400
1500	427	350
1250		300
1000	320	250
900		200
800	246	180
700		160
600	192	140
500		120
450	160	100
400		90
350	128	80
300		70
250	96	60
200		50
180	64	45
160		40
140	48	35
120		30
100	32	25
90		20
80	24	15
70		10
60	16	
50		
40		
30	8	

NOTE:

Based on Kutter's Formulae with $n = .013$
 Quantities per Ac - $R=1 = .004$ cfs, $C = .015$ cfs, $H.I. = .021$ c.f.s.

PIPE DIAMETER

18" 15" 15" 12" 10" 8" 6"
 $\frac{3}{4}$ Full $\frac{1}{2}$ Full

DISCHARGE IN C.F.S.

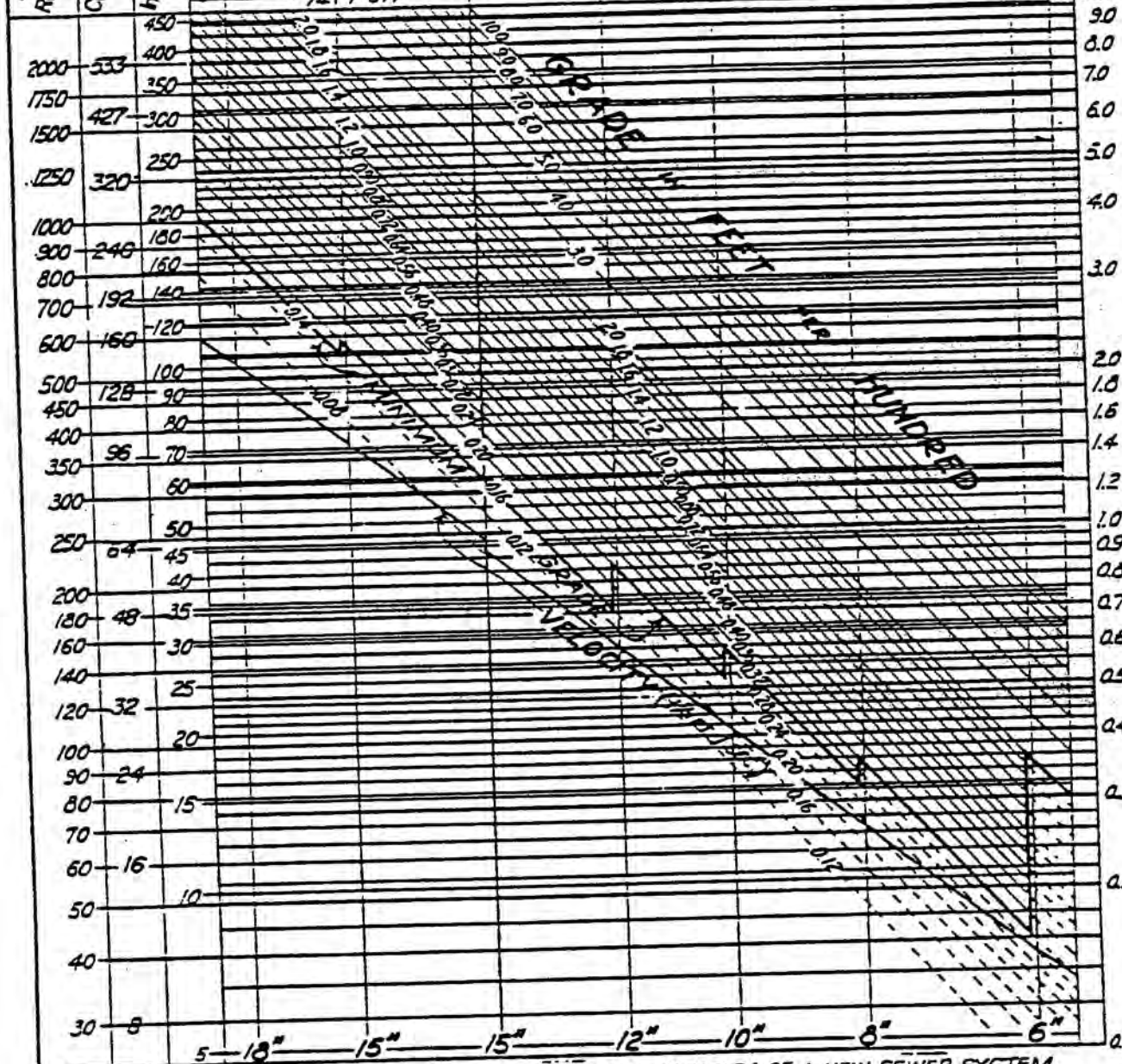

NOTE: USE 15" 1/2 FULL FOR COMPUTING DESIGN CAPACITY OF A NEW SEWER SYSTEM.
 USE 15" 3/4 FULL FOR CHECKING CAPACITY OF EXIST. SEWER SYSTEM.

FLOW DIAGRAM FOR THE DESIGN OF CIRCULAR SANITARY SEWERS

COUNTY OF LOS ANGELES DEPARTMENT OF PUBLIC WORKS		COUNTY ENGINEER STANDARD DATE: 3 / 80 DESIGN: <i>[Signature]</i> RCE 1210223
<i>[Signature]</i> ASSISTANT DEPUTY	<i>[Signature]</i> COUNTY ENGINEER	S-C4

**NORMAL DROPS STRAIGHT THROUGH MANHOLES FOR MINIMUM GRADES OR GREATER
EXCEPT AS NOTED BELOW**

INLET		8"	10"	12"	15"	18"
OUTLET	8"	.10	.10	.10	.10	.10
	10"	.17	.10	.10	.10	.10
	12"	.33	.17	.10	.10	.10
	15"	.58	.42	.25	€	—
	18"	.80	.71	.63	.50	€

NOTE: FOR RIGHT ANGLE CONNECTIONS, ADD 0.10 OF A FOOT TO EACH OF THE ABOVE VALUES.

WHEN PIPES ON BOTH SIDES OF THE MANHOLE ARE THE SAME SIZE AND THE AVERAGE OF THE GRADES ON BOTH SIDES EXCEEDS 2.50 %, AN AVERAGE DROP SHALL BE TAKEN ACROSS THE MANHOLE, NOT TO EXCEED .60, INSTEAD OF THE VALUES IN THE ABOVE TABLE.

**NORMAL DROPS STRAIGHT THROUGH MANHOLES FOR GRADES LESS THAN MINIMUM
EXCEPT AS NOTED BELOW**

INLET		8"	10"	12"	15"	18"
OUTLET	8"	€	—	—	—	—
	10"	.10	€	—	—	—
	12"	.18	.10	€	—	—
	15"	.31	.23	.14	€	—
	18"	.80	.71	.63	.50	€

NOTE: FOR RIGHT ANGLE CONNECTIONS ADD 0.10 OF A FOOT TO EACH OF THE ABOVE VALUES.

- NOTES:
- € INDICATES NO DROP ACROSS M.H. AND ELEV. TO BE SHOWN AT THE CENTER OF MANHOLE.
 - FOR TRAP M.H.'S ALL INLETS TO BE AT SAME ELEVATION. OUTLET MAY BE 0.05 OF A FOOT LOWER.
 - PERMISSION FOR DEVIATIONS FROM THE ABOVE VALUES, OR SMALLER DROPS FOR PIPES OVER 18", TO BE APPROVED BY THE COUNTY ENGINEER.
 - THE MINIMUM GRADES FOR VARIOUS PIPE SIZES ARE DETERMINED BY THE CHART ON COUNTY ENGINEER STANDARD S-C4

TABLE FOR COMPUTING NORMAL DROPS THROUGH MANHOLES

COUNTY OF LOS ANGELES
DEPARTMENT OF PUBLIC WORKS



COUNTY ENGINEER
STANDARD **S-C5**
DATE: 3/80

P. C. C.
ASSISTANT DEPUTY



Stephen J. Kruse
COUNTY ENGINEER

DESIGN *[Signature]* RCE
10223



SANITARY SEWERS

-  INDICATES SANITARY SEWERS AND MANHOLES TO BE CONSTRUCTED.
-  INDICATES EXISTING SANITARY SEWERS AND MANHOLES.
-  INDICATES PROPOSED SANITARY SEWERS AND MANHOLES, OR SHOWN ON ANOTHER VIEW.



Y's & T's

-  INDICATES "Y" BRANCH ONLY.
-  INDICATES "T" OR "Y" BRANCH. (OPTION)





HOUSE LATERALS

- H.L.'s** INDICATES HOUSE LATERALS
-  INDICATES HOUSE LATERAL TO BE CONSTRUCTED.
-  INDICATES EXISTING HOUSE LATERAL.
-  INDICATES PROPOSED HOUSE LATERAL, OR SHOWN ON ANOTHER VIEW.



CHIMNEY PIPE

-  (PROFILE) - INDICATES CHIMNEY PIPE PER S-27.
-  (PLAN) - INDICATES CHIMNEY BASE.
-  (PLAN) - INDICATES A SINGLE AND DOUBLE "Y" BRANCH ON CHIMNEY PIPE.





CONCRETE CRADLE OR ENCASEMENT

-  (PROFILE) - INDICATES CONCRETE CRADLE PER S-23, CASE I.
-  (PROFILE) - INDICATES CONCRETE ENCASEMENT PER S-23, CASE II.
-  (PROFILE) - INDICATES SPECIAL CRADLE PER S-23, CASE III.
-  (PROFILE) - INDICATES SPECIAL ENCASEMENT PER S-23, CASE III.
-  (PLAN) - INDICATES CRADLE OR ENCASEMENT PER S-23, ALL CASES.

MANHOLES

-  INDICATES MANHOLE.
-  INDICATES MANHOLE WITH ADDITIONAL INLETS.
-  INDICATES SHALLOW MANHOLE.

GENERAL

-  ON PLANS INDICATES EXISTING BUILDING.
-  INDICATES BOUNDARY LINE OF DISTRICT.
-  INDICATES BOUNDARY LINE OF A CITY.
-  INDICATES EXISTING CURB.
-  INDICATES CURB LINE. (FUTURE)

UNDERGROUND UTILITIES

- W- WATER
 - G- NATURAL GAS
 - GASO- GASOLINE
 - T- TELEPHONE
 - E- ELECTRICAL
- } INDICATES TYPE OF EXISTING UNDERGROUND UTILITIES.

NOTE: ABBREVIATIONS USED ON PLANS, MAPS AND OTHER DOCUMENTS SHALL BE PER SECTION 1-3 OF THE STANDARD SPECIFICATIONS FOR PUBLIC WORKS CONSTRUCTION.

LEGEND FOR SANITARY SEWER PLANS AND PROFILES AND DISTRICT MAPS

COUNTY OF LOS ANGELES
DEPARTMENT OF PUBLIC WORKS

COUNTY ENGINEER
STANDARD

DATE: 3/80

S-1

DESIGN

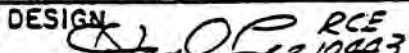

ASSISTANT DEPUTY

COUNTY ENGINEER

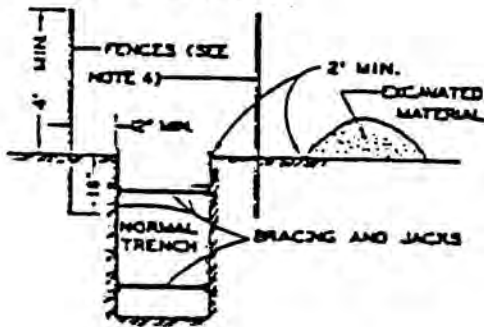

RCE
10003

PRIOR TO THE END OF EACH WORK DAY THE CONTRACTOR SHALL EITHER BACKFILL THE TRENCH OR ERECT AND MAINTAIN FENCES OR COVERS. THE FOLLOWING ARE MINIMUM ACCEPTABLE MEASURES ONLY, AND COMPLIANCE WITH THIS STANDARD DOES NOT RELIEVE THE CONTRACTOR OF HIS OBLIGATION TO PROTECT THE PUBLIC BY ALL NECESSARY MEANS.

I. FENCES

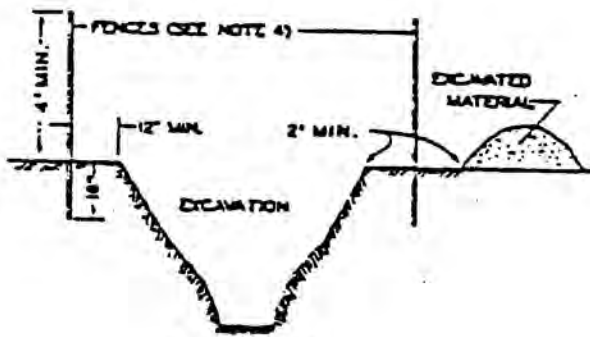

CASE A



CASE B

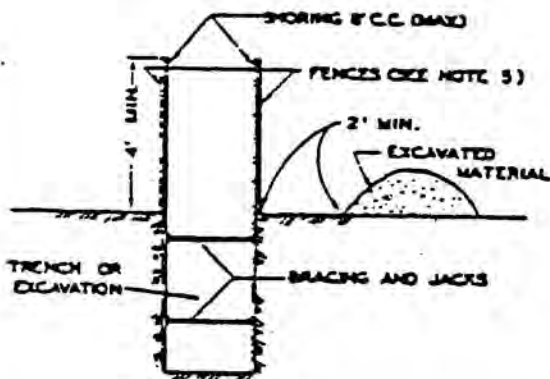

CASE C

II. COVER

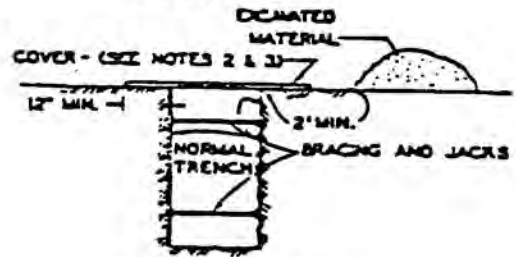

NOTES

1. EXCEPTIONS: FENCES OR COVERS WILL BE OPTIONAL WITH THE CONTRACTOR IF THE EXCAVATION IS EITHER:
 - a. - LESS THAN 3 FEET DEEP.
 - b. - LESS THAN 3 FEET DEEP WITH SUFFICIENT WARNING DEVICES SUCH AS LANTERNS, FLASHERS, OR BARRICADES.
 - c. - FOR CASE B, LESS THAN 3 FEET DEEP IN THE VERTICAL PORTION WITH UPPER SIDE SLOPES OF 1:1 OR FLATTER.
 - d. - IN AN AREA THAT IS NOT ACCESSIBLE TO THE PUBLIC OR THAT IS MORE THAN 1/2 MILE FROM ANY PLACE OF PUBLIC USE OR HABITATION.
2. COVERS MAY BE:

a. - 1/2" STEEL PLATES	}	NON-VEHICULAR TRAFFIC
b. - 2" PLANKS		
c. - 3/4" PLYWOOD		
3. WHEN STEEL PLATE COVER IS BEING USED FOR VEHICULAR TRAFFIC, IT IS THE CONTRACTOR'S RESPONSIBILITY TO PROVIDE PROPER TRENCH BRACING AND STEEL PLATES WITH SUFFICIENT STRENGTH TO WITHSTAND TRAFFIC LOADING.
4. FOR CASES 'A' AND 'B', FENCES MAY BE:
 - a. - WOOD PICKETS TIED WITH WIRE AND POSTS 8' C.C.
 - b. - 2" X 4" POSTS 8' C.C. AND WIRE MESH.
 - c. - 2" X 4" POSTS 8' C.C. WITH TOP AND BOTTOM RAIL AND CHICKEN WIRE.
 - d. - SAME AS NOTE 3 ITEM c.
5. FOR CASE 'C', FENCES MAY BE:
 - a. - WOOD PICKETS TIED WITH WIRE AND BOTTOM RAIL.
 - b. - TOP AND BOTTOM RAIL WITH CHICKEN WIRE.
 - c. - THREE RAILS EQUALLY SPACED WITH BOTTOM RAIL 6" ABOVE GROUND.
6. POST FOR FENCES SHALL BE 2" X 4" WOOD OR EQUIVALENT STEEL OR PIPE. IN PAVED AREAS, POSTS MAY BE FLUSH WITH SURFACE IF SUFFICIENTLY ANCHORED AND BRACED. RAILS SHALL BE 1" X 4" WOOD.

MINIMUM PUBLIC SAFETY REQUIREMENTS

COUNTY OF LOS ANGELES
DEPARTMENT OF PUBLIC WORKS

COUNTY ENGINEER
STANDARD

S-2

DATE: 3/80

DESIGN

RCE

10013

[Signature]
ASSISTANT DEPUTY

[Signature]
COUNTY ENGINEER

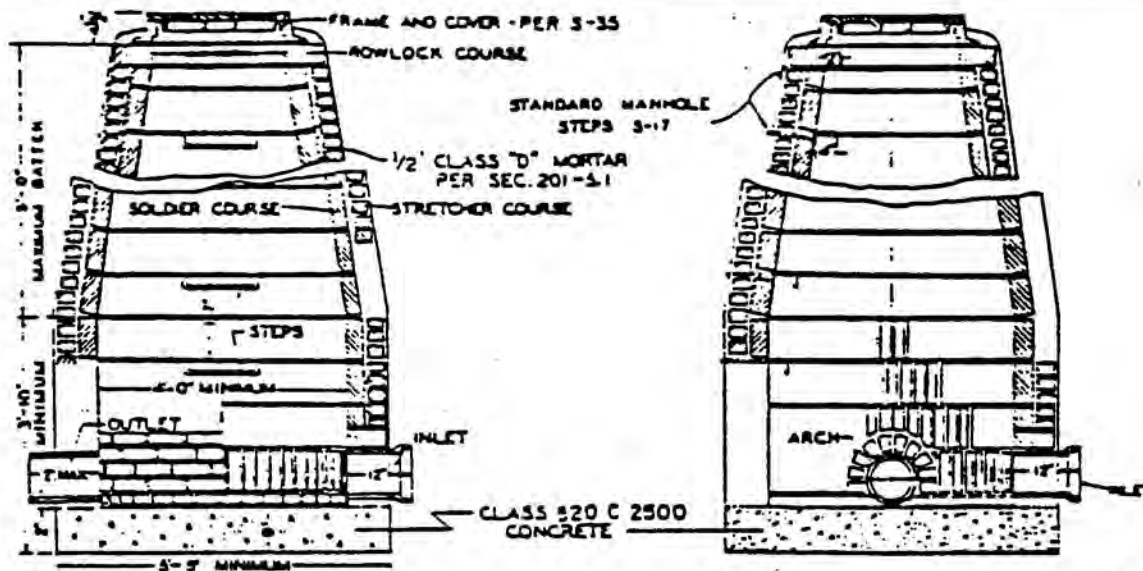

SECTIONAL ELEVATION A-A

SECTIONAL ELEVATION B-B

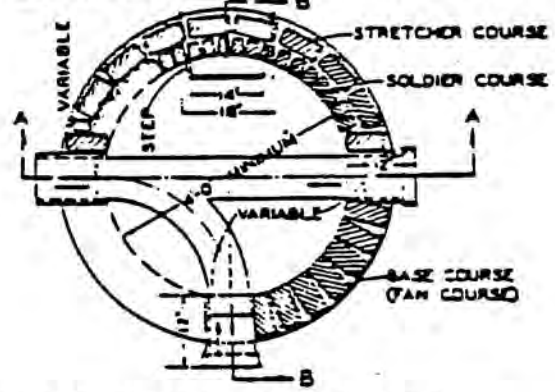

SECTIONAL PLAN OF BASE

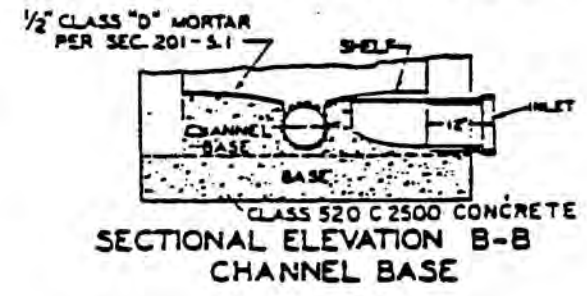

SECTIONAL ELEVATION B-B CHANNEL BASE

NOTES

1. CONCRETE BASE: DURING CONSTRUCTION, ALL PIPES SHALL BE RIGIDLY SUPPORTED BY BRICK PIERS ONE FOOT DEEP, LOCATED JUST OUTSIDE THE STRUCTURE. CONSTRUCT TOP OF CONCRETE BASE TWO INCHES BELOW INVERT OF LOWEST PIPE. FILL SPACE BENEATH PIPE WITH MORTAR AND SHOVE FROM BOTH SIDES WITH BASE COURSE BRICK TO FORM A WATER TIGHT JOINT. CONCRETE SHALL SET UNDISTURBED FOR 24 HOURS.
2. BASE OR FAN COURSE: LAY BRICK FLAT ON RADIAL LINES WITH TOPS TO SAME LEVEL.
3. ARCHES: LAY SPALLED BRICK ON EDGE TO FORM A TRUE RADIAL ARCH WITH FULL MORTAR JOINT AROUND ALL PIPE OPENINGS. TURN ARCH OF TWO SUCH COURSES OVER PIPES 15 INCH OR MORE IN DIAMETER.
4. SOLDIER COURSES: LAY INSIDE BRICK ON RADIAL LINES VERTICAL FROM THE BASE COURSE TO THE START OF THE BATTER. LAY SUCCEEDING COURSES WITH A UNIFORM BATTER TO OBTAIN AN INSIDE DIAMETER OF 1'-11" AT TOP OF LAST OR FRACTIONAL SOLDIER COURSE. USE SPLIT BRICK TO CLOSE SOLDIER COURSE.
5. STRETCHER COURSES: LAY OUTSIDE BRICK FLAT IN A DEEP BED OF MORTAR. SHOVE BRICK HARD TOGETHER AGAINST ADJACENT SOLDIER COURSE.
6. ROWLOCK COURSE: LAY LAST COURSE OF BRICK RADIAL ON EDGE ACROSS SOLDIER AND STRETCHER COURSES, WITH TOPS PARALLEL.
7. WALL THICKNESS: BRICKWORK SHALL BE 8 INCHES THICK EXCEPT AS OTHERWISE SPECIFIED, OR WHEN DEPTH EXCEEDS 22 FEET, WALLS BELOW 22 FEET SHALL BE 12 INCHES THICK AND THE CONCRETE BASE CORRESPONDINGLY EXTENDED.
8. STEPS: SET LOWER STEP ON TOP OF THIRD SOLDIER COURSE AND NOTCH BRICK ABOVE. PLACE UPPER STEP IMMEDIATELY BELOW ROWLOCK COURSE WITH TREAD OF STEP PROJECTING UPWARD AND SET TWO INCHES OUT FROM WALL. OUTSIDE PROJECTION OF TOP STEP TO BE SENT DOWN.
9. JOINTS: INSIDE JOINTS SHALL BE NEATLY STRUCK AND POINTED AND SHALL NOT EXCEED 3/8" IN THICKNESS.
10. CHANNEL BASE: THE DEPTH OF CHANNEL IN CHANNEL-BASE SHALL EQUAL THE PIPE-DIAMETER FOR ALL SIZES OF PIPE. FOR SPECIAL CHANNELS IN TRAP OR GAUGING MANHOLES SEE S-10, S-11, OR SPECIAL PLANS.

BRICK MANHOLE

COUNTY OF LOS ANGELES
DEPARTMENT OF PUBLIC WORKS

COUNTY ENGINEER
STANDARD
DATE: 3/80 - S-3

[Signature]
ASSISTANT DEPUTY

[Signature]
COUNTY ENGINEER

DESIGN
[Signature] RCE
10043

NOTE: TO BE USED FOR DEPTHS LESS THAN 5 FEET FROM THE TOP OF THE MANHOLE TO THE TOP OF THE SEWER PIPE.

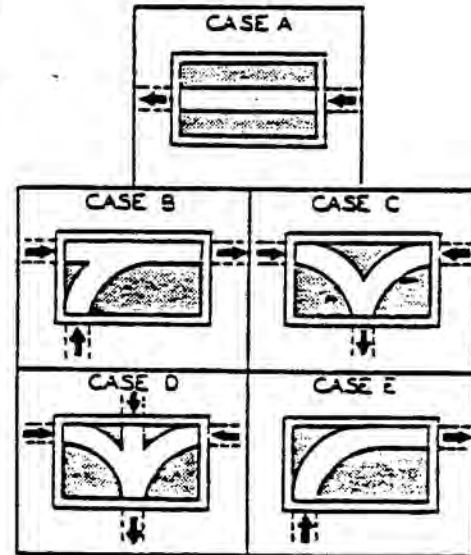
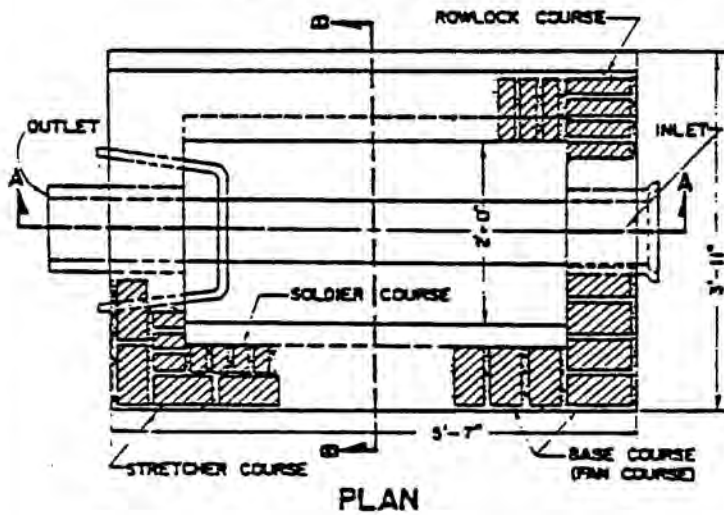
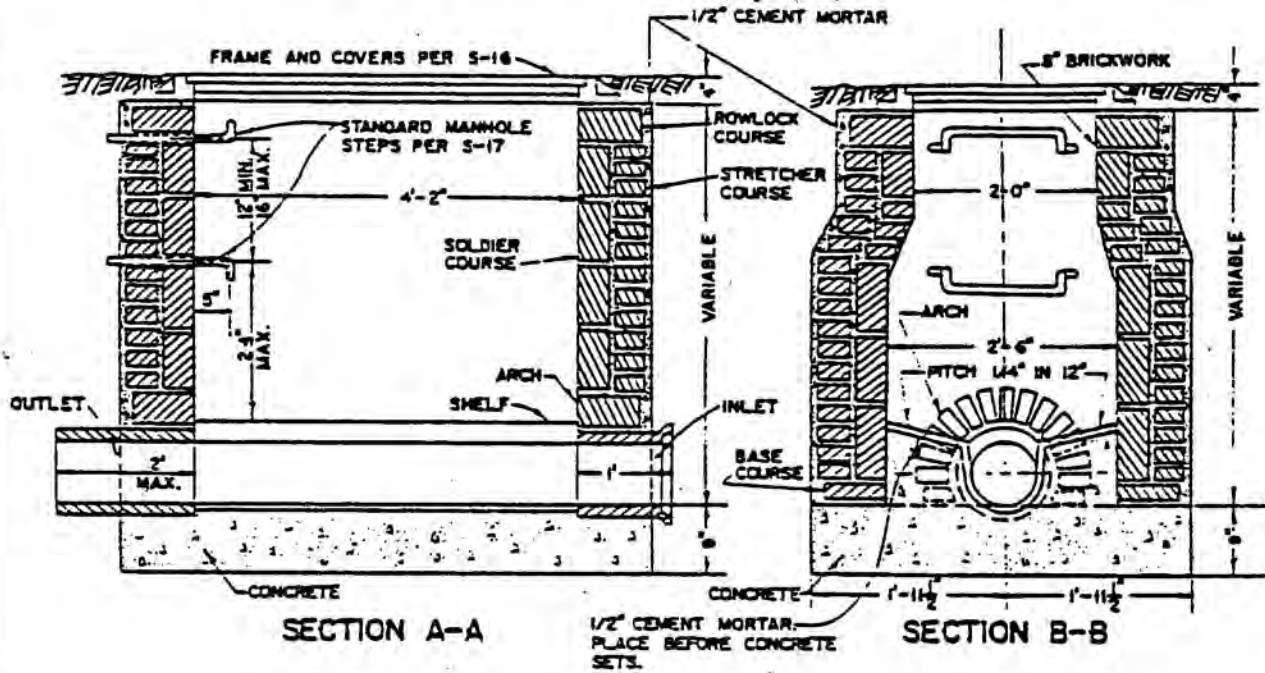

- NOTES
1. THE DEPTH OF CHANNELS SHALL EQUAL THE PIPE DIAMETER FOR ALL SIZES OF PIPE.
 2. ALL CONCRETE TO BE CLASS 470 C 2500.
 3. ALL CEMENT MORTAR SHALL BE CLASS "D" PER SECTION 201-S.1

PLACEMENT OF CHANNELS

RECTANGULAR SHALLOW MANHOLE

COUNTY OF LOS ANGELES
DEPARTMENT OF PUBLIC WORKS

COUNTY ENGINEER
STANDARD

S-7

DATE: 3/80

DESIGN

[Signature]
ASSISTANT DEPUTY

[Signature]
COUNTY ENGINEER

[Signature] RCE
10243

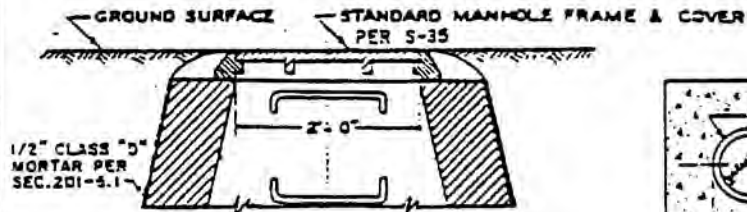

1/2" CLASS "D" MORTAR PER SEC. 201-5.1

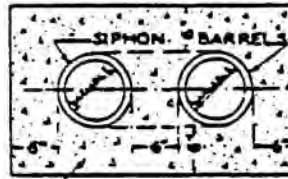

PIPE ENCASEMENT DETAIL

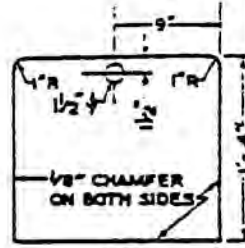

3/8" ALUMINUM PLATE ALLOY 6061-T6 OR APPROVED EQUAL ALUMINUM GATE DETAIL

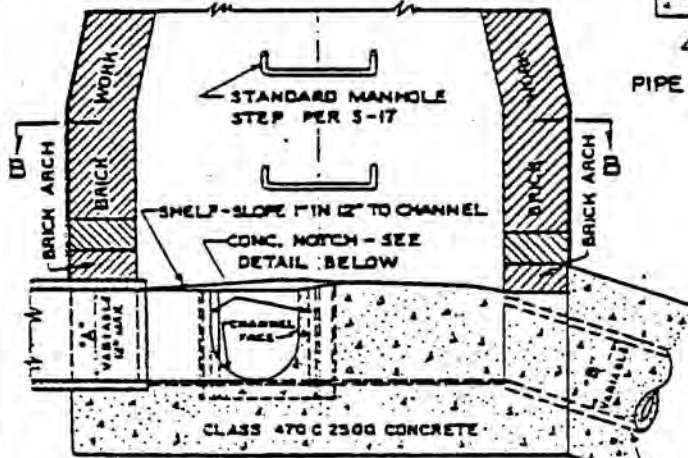

SECTION A-A

NOTES

1. FOR OTHER MANHOLE DETAILS SEE PLAN NO. S-3 OR S-36.
2. USE FOR ANY COMBINATION OF SIZES TO A MAXIMUM OF TWO 12" PIPES.
3. FOR PIPE DIAMETERS GREATER THAN 12" CONTACT SANITATION DIVISION.
4. ENCASE SIPHON ONLY TO THE EXTENT SHOWN ON PLANS.
5. PROVIDE ONE ALUMINUM GATE WITH EACH SIPHON MANHOLE.
6. THE DOWNSTREAM LEGS OF SIPHON BARRELS SHALL NOT EXCEED A GRADE OF +30.00%.

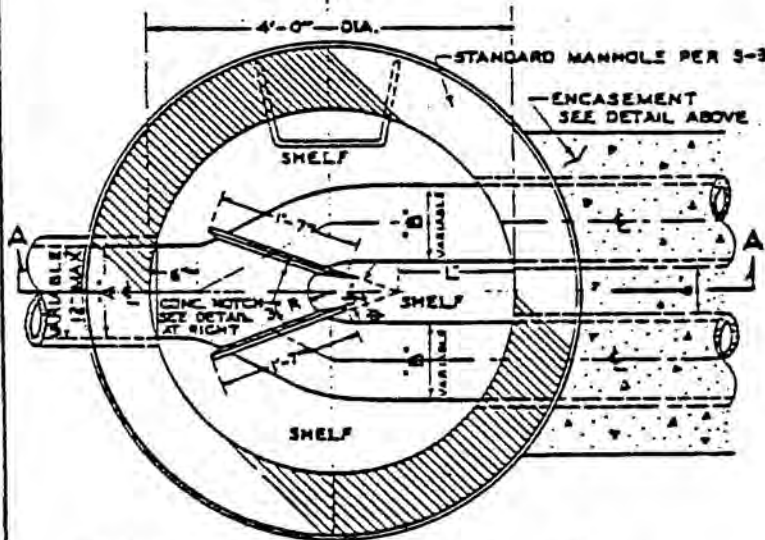

SECTIONAL PLAN B-B

TABLE OF DIMENSIONS

A	B	L	φ
8"	6"	1'-0 1/2"	13"
8"	8"	1'-0 1/2"	13"
10"	8"	1'-0 1/2"	13"
10"	10"	1'-3 1/8"	20"
12"	10"	1'-3 1/8"	20"
12"	12"	1'-6 3/8"	30"

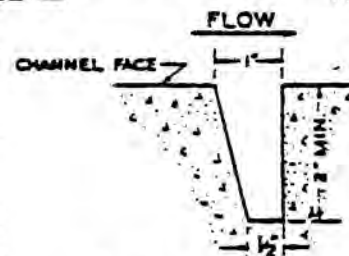

CROSS SECTION OF NOTCH SIDES AND BOTTOM

SIPHON MANHOLE

COUNTY OF LOS ANGELES
DEPARTMENT OF PUBLIC WORKS

COUNTY ENGINEER
STANDARD

S-8

DATE: 3/80

DESIGN

RCE
10643

[Signature]
ASSISTANT DEPUTY

[Signature]
COUNTY ENGINEER

TO BE USED ONLY UPON APPROVAL OF COUNTY ENGINEER

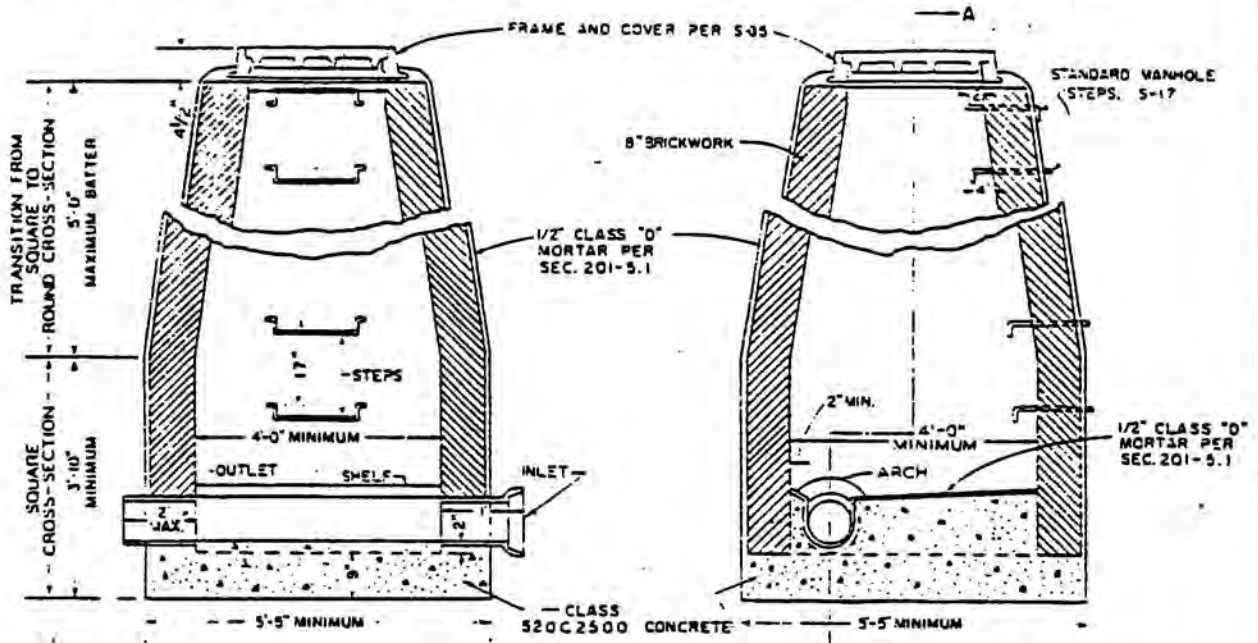

SECTIONAL ELEVATION A-A

SECTIONAL ELEVATION B-B

NOTES

1. ARCHES: LAY SPALLED BRICK ON EDGE TO FORM A TRUE RADIAL ARCH WITH FULL MORTAR JOINT AROUND ALL PIPE OPENINGS. TURN ARCH OF TWO SUCH COURSES OVER PIPES 1/2" OR MORE IN DIAMETER.
2. STEPS: SET LOWER STEP ON TOP OF THIRD SOLDIER COURSE AND NOTCH BRICK ABOVE. PLACE UPPER STEP IMMEDIATELY BELOW ROWLOCK COURSE WITH TREAD OF STEP PROJECTING UPWARD AND SET TWO INCHES OUT FROM WALL. OUTSIDE PROJECTION OF TOP STEP TO BE BENT DOWN.
3. CHANNEL BASE: THE DEPTH OF CHANNEL IN CHANNEL BASE SHALL EQUAL THE PIPE DIAMETER FOR ALL SIZES OF PIPE.
4. BRICKWORK: BRICKWORK TO BE CONSTRUCTED AS SHOWN ON STANDARD DRAWING S-3.
5. CONCRETE BASE: CONCRETE BASE TO BE CONSTRUCTED AS PER NOTES NO. 1 & 7 ON STANDARD DRAWING S-3.

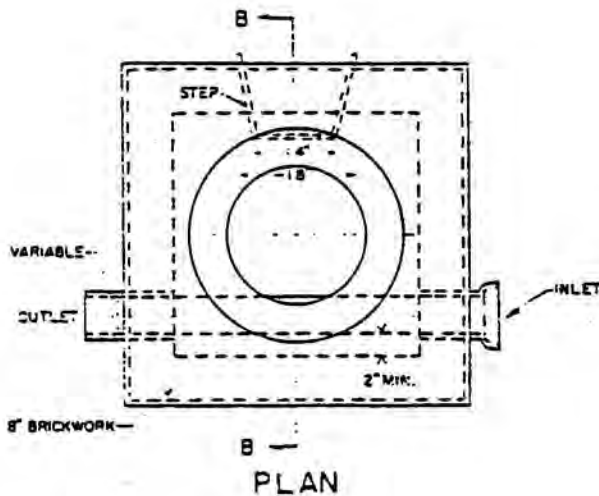

PLAN

SPECIAL SQUARE BASE MANHOLE

COUNTY OF LOS ANGELES
DEPARTMENT OF PUBLIC WORKS

COUNTY ENGINEER
STANDARD

S-9

DATE: 3/80

DESIGN

[Signature]
ASSISTANT DEPUTY

[Signature]
COUNTY ENGINEER

[Signature] RCE
10403

FOR TRAP CASTING S-18

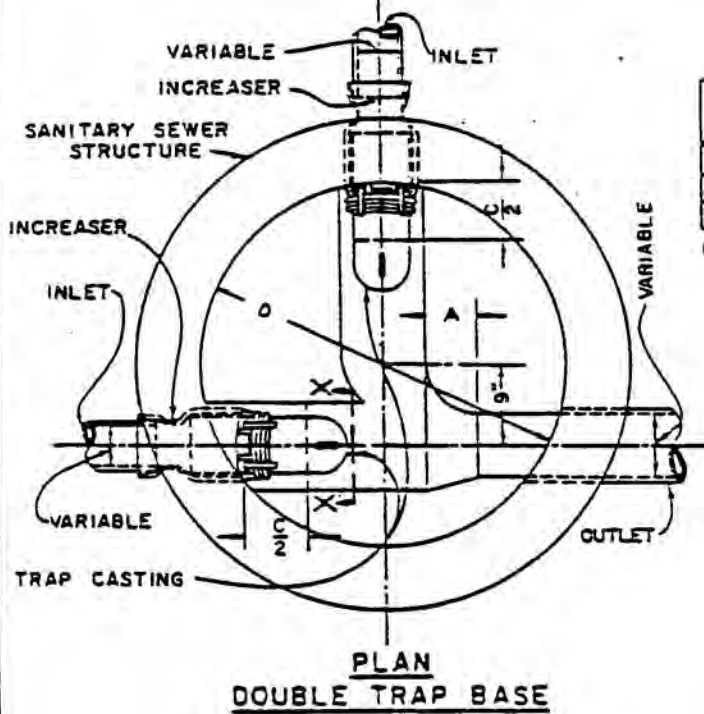
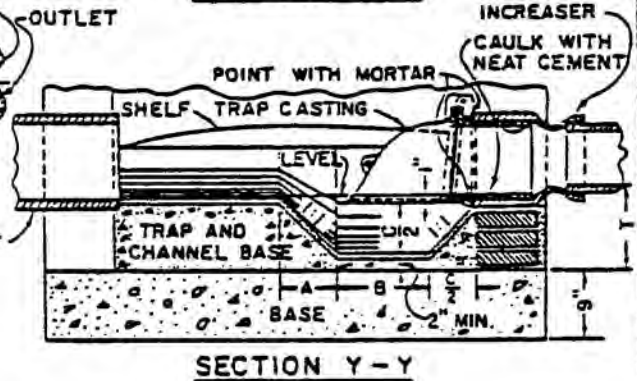
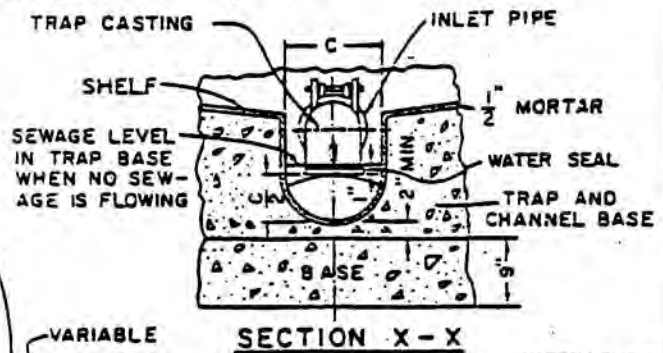
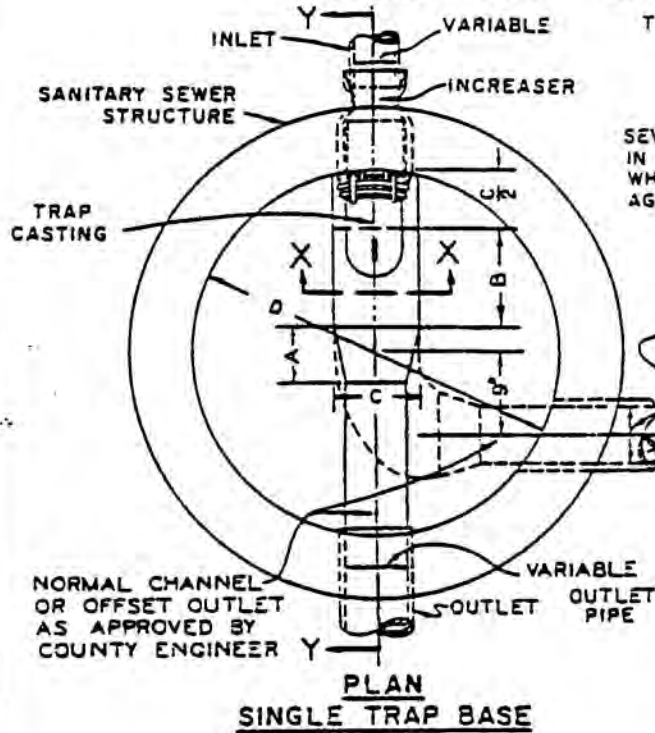

TRAP BASES

INLET DIAM.	INLET INCREASER	TRAP SIZE	TRAP PER	DIAM. OF MANHOLE BASE (D)		
				OUTLET DIAMETER	5"	10"
8"	8" x 10"	10"	S-18	4"	4"	4"
10"	10" x 12"	12"	S-18	4"	4"	4"
12"	12" x 15"	15"		SEE S-11		

(FOR 15" INLETS AND LARGER SEE S-11; NO INCREASER REQUIRED)

BASE DIMENSIONS					
TRAP DIAM.	A	B	C	A+B+C/2	T MIN.
10"	7 1/2"	14 1/2"	13"	28 1/2"	8"
12"	8 1/2"	18 1/2"	15"	32 1/2"	10"
15"	SEE S-11				

NOTES

- WHERE A TRAP IS NECESSARY IN AN EXISTING STRUCTURE, BREAK OUT CONCRETE AND CONSTRUCT NEW BASE.
- FOR OTHER MANHOLE DETAILS, SEE PLAN NO. S-3 OR S-34.
- ALL CEMENT MORTAR SHOWN HEREON SHALL BE CLASS "D" PER SECTION 201-3.1.
- WATER SEAL SHALL BE 1" MINIMUM.

TRAP MANHOLE BASE

COUNTY OF LOS ANGELES
 DEPARTMENT OF PUBLIC WORKS
Assistant Deputy
 ASSISTANT DEPUTY

COUNTY ENGINEER
 STANDARD
 DATE: 3/80
 DESIGN
 COUNTY ENGINEER
 S-10
 RCE
 15683

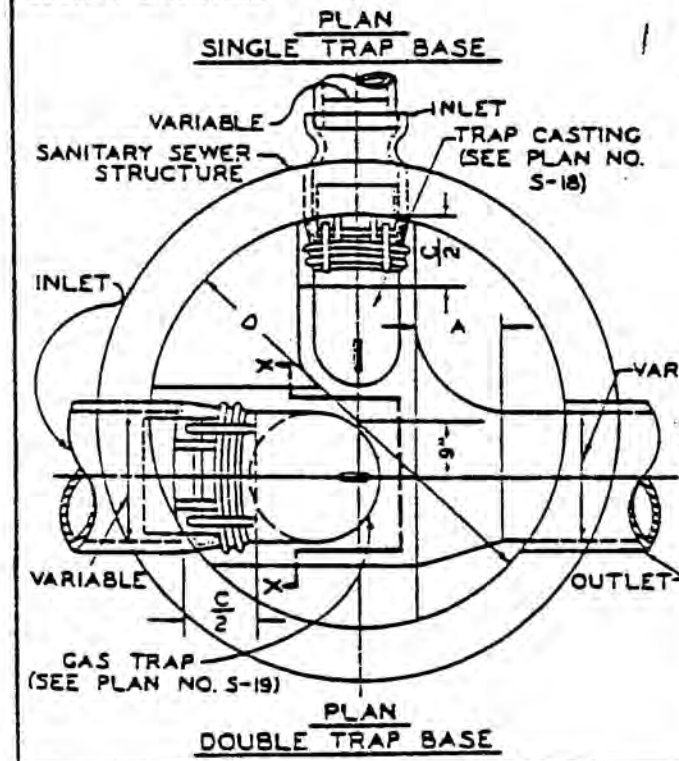
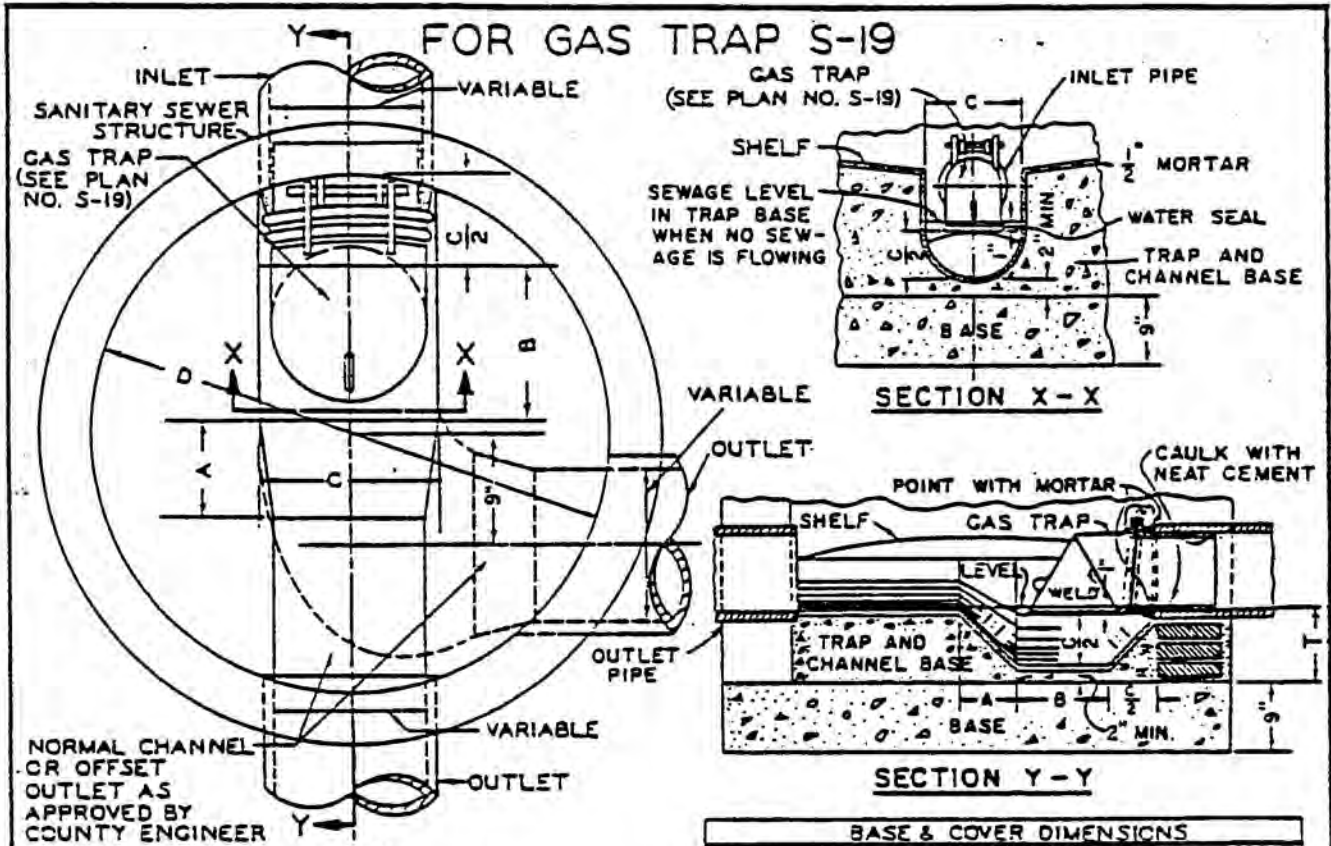

BASE & COVER DIMENSIONS

INLET DIAM.	BASE & COVER DIMENSIONS				FRAME & COVER
	A	B	C	T MIN.	
15"	10"	17 1/2"	18"	11"	PER S-33
18"	11 1/2"	19 1/2"	21"	13"	29" CLEAR OPENING MINIMUM OF A TYPE APPROVED BY THE COUNTY ENGINEER
21"	13"	21 1/2"	24"	14"	

TRAP BASES

INLET DIAM. OF MANHOLE BASE (D) & TRAP SIZE	OUTLET DIAMETER			
	15"	18"	21"	24"
15"	4"	5"	5"	5"
18"	—	5"	5"	5"
21"	—	—	6"	6"

- #### NOTES
- FOR OTHER MANHOLE DETAILS, SEE PLAN NO. S-3 OR S-36.
 - FOR DETAILS OF GAS TRAP FABRICATION FOR 15" 18" AND 21" GAS TRAP TRAPS SEE PLAN NO. S-19.
 - WATER SEAL SHALL BE 1" MINIMUM.
 - FOR TRAP INLETS LARGER THAN 21" SHOW BASE DETAIL ON PROFILE AS APPROVED BY THE COUNTY ENGINEER.
 - ALL CEMENT MORTAR SHOWN HEREON SHALL BE CLASS "D" PER SECTION 201-31
 - DOUBLE TRAP BASES ARE NOT ALLOWED IF ANY INLET IS 18" IN DIAMETER OR GREATER.

LARGE GAS TRAP MANHOLE BASE

COUNTY OF LOS ANGELES DEPARTMENT OF PUBLIC WORKS	COUNTY ENGINEER STANDARD S-11
ASSISTANT DEPUTY	COUNTY ENGINEER
	DATE: 3/80 DESIGN: RCE 12 10443

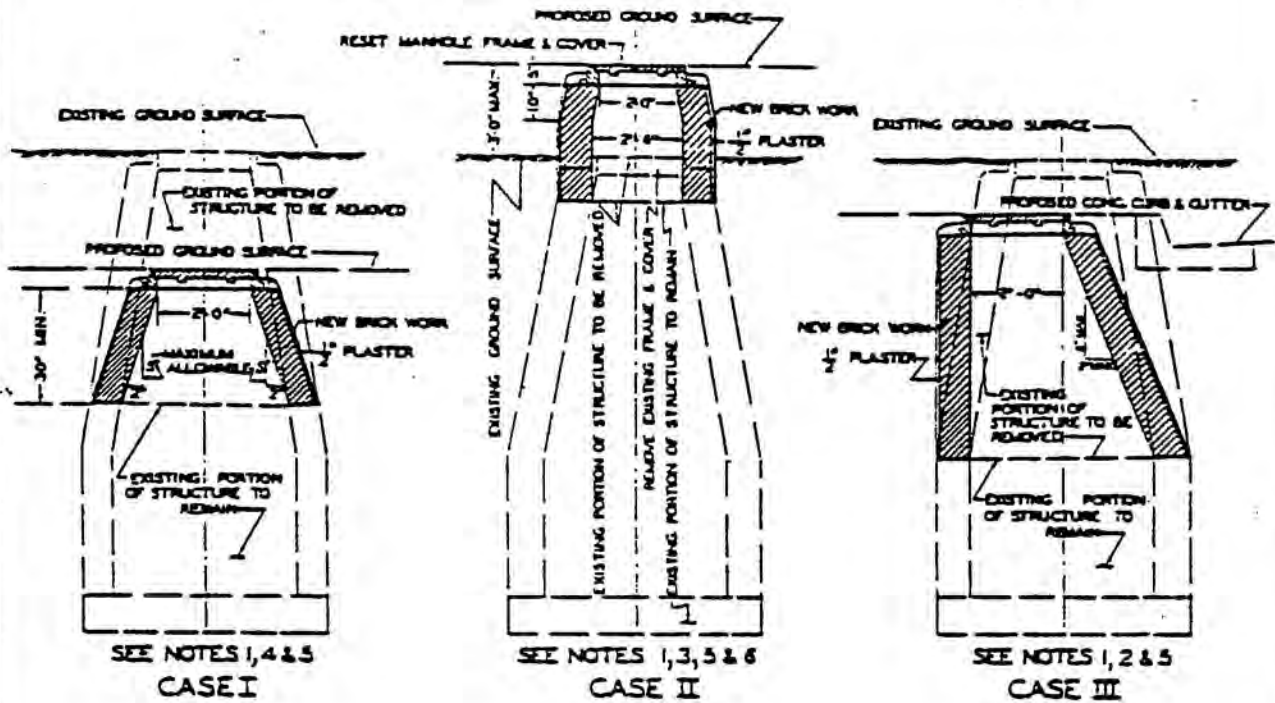

NOTES

1. PRIOR TO THE REMOVAL OF THE FRAME OF ANY SEWER MANHOLE, THE CHANNEL OF THE MANHOLE SHALL BE COMPLETELY COVERED WITH PLANKING OR OTHER SUITABLE MATERIAL SO AS TO PREVENT DEBRIS FROM ENTERING THE CHANNEL AFTER THE MANHOLE RECONSTRUCTION HAS BEEN COMPLETED ALL DEBRIS SHALL BE REMOVED FROM WITHIN THE MANHOLE AND THE COVER OVER THE CHANNEL SHALL BE REMOVED.
2. WHEN IT BECOMES NECESSARY TO CONSTRUCT A STRAIGHT SIDED MANHOLE THE BRICK WORK SHALL BE BROKEN DOWN TO A POINT EQUAL TO OR BELOW THE HIGHEST POINT OF THE VERTICAL WALL THE SLOPE OF THE CORBELED SIDE SHALL NOT EXCEED 12 INCHES IN 30 INCHES. THE MANHOLE STEPS SHALL BE PLACED ON THE VERTICAL SIDE.
3. WHEN THE TOP OF A SEWER MANHOLE IS TO BE RAISED 3 FT OR LESS THE BRICK WORK SHALL BE BROKEN DOWN TO A POINT WHERE THE INSIDE DIAMETER IS A MINIMUM OF 30 INCHES. THE MANHOLE WALL SHALL THEN BE CONSTRUCTED VERTICALLY TO A POINT 15 INCHES BELOW THE TOP OF MANHOLE. SEE CASE II.
4. WHEN RECONSTRUCTION CAUSES THE DEPTH OF A MANHOLE TO BECOME LESS THAN 5 FT FROM THE INVERT OF THE CHANNEL TO THE TOP OF THE MANHOLE THE BRICK WORK SHALL BE ENTIRELY BROKEN DOWN AND A SHALLOW RECTANGULAR MANHOLE CONSTRUCTED AS PER L.A. COUNTY ENGINEER STANDARDS S-7 & S-16.
5. MANHOLE STEPS, PER L.A. COUNTY ENGINEER STANDARD S-17, SHALL BE SO PLACED SO AS NOT TO BE MORE THAN 17 INCHES APART WITH THE TOP STEP BEING PLACED IMMEDIATELY UNDER THE TOP ROWLOCK COURSE OF BRICK.
6. WHERE THE TOP OF A MANHOLE IS TO BE RAISED IN EXCESS OF 3 FT, IT SHALL BE RECONSTRUCTED IN ACCORDANCE WITH S-3.

RECONSTRUCTION OF BRICK MANHOLE TOPS

COUNTY OF LOS ANGELES
DEPARTMENT OF PUBLIC WORKS

[Signature]
ASSISTANT DEPUTY

[Signature]
COUNTY ENGINEER

COUNTY ENGINEER
STANDARD

S-12

DATE: 3/80

DESIGN

[Signature] RCE
10663

GENERAL NOTES

1. INVERT ELEVATION OF "0" X 1" STUB AT THE INSIDE FACE OF MANHOLE TO BE 0.10 FT. HIGHER THAN EXISTING OUTLET INVERT ELEVATION.
2. THE CORE CUT HOLE SHALL BE MADE WITH EQUIPMENT SPECIALLY DESIGNED TO CUT A SMOOTH HOLE WITHOUT SPALLING OR DAMAGE TO THE REINFORCING STEEL OR STRUCTURE.
3. "0" TO BE 9" MINIMUM.
4. COUNTY ENGINEER SHOULD BE NOTIFIED BY TELEPHONE 974-7253 FOR INSPECTION AT LEAST 24 HOURS BEFORE INSPECTION IS TO BE MADE.
5. ALL WORK SHOULD BE UNCOVERED AND CONVENIENT FOR THE COUNTY ENGINEER'S INSPECTION.
6. ALL CEMENT MORTAR SHALL BE CLASS "0" PER SECTION 201-5.1.
7. CONSULT COUNTY ENGINEER PRIOR TO BREAKING INTO SHALLOW MANHOLES.

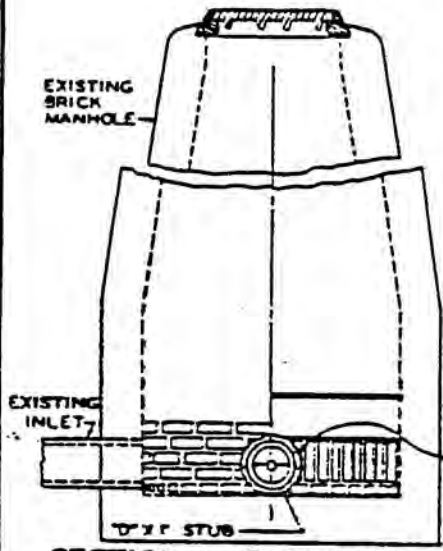

SECTIONAL ELEVATION A-A

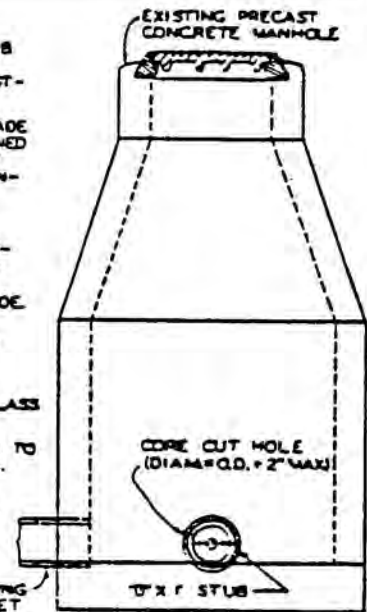

SECTIONAL ELEVATION C-C

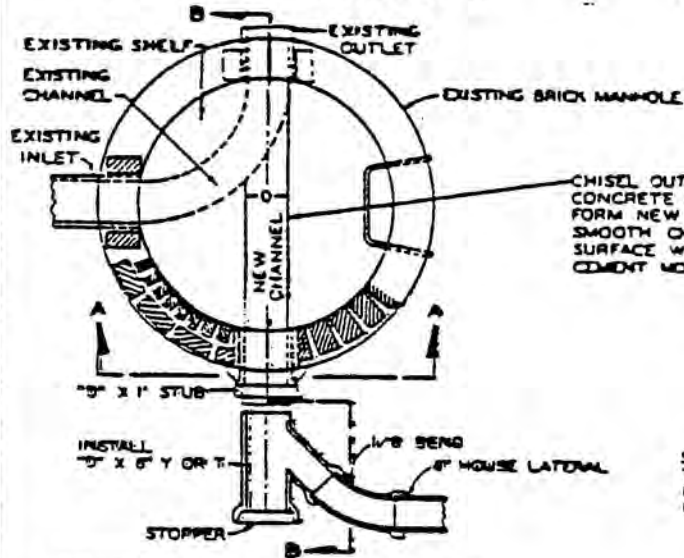

SECTIONAL PLAN OF BASE

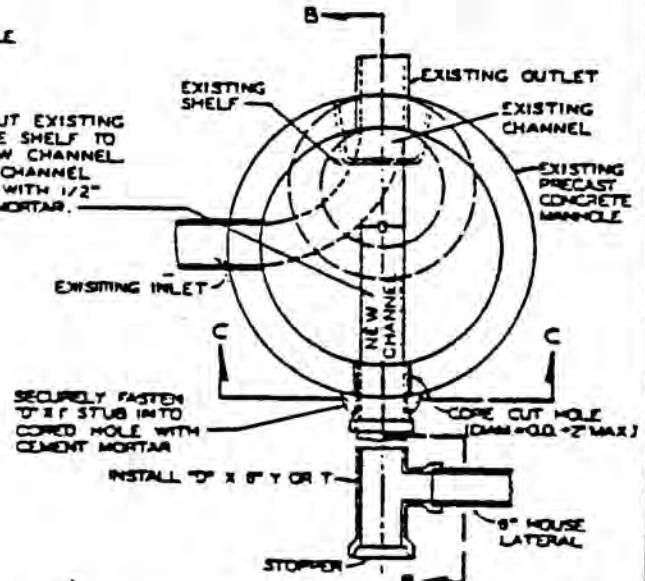

SECTIONAL PLAN OF BASE



SECTIONAL ELEVATION B-B CHANNEL BASE

HOUSE LATERAL NOTES

1. Y TO BE LAID WITH 1/8" RISE PER FOOT AND 6" SPUR AT 45° FROM HORIZONTAL.
2. "0" X 4" Y OR T AND 6" HOUSE LATERAL MAY SUBSTITUTED FOR "0" X 6" Y OR T AND 6" HOUSE LATERAL UPON APPROVAL OF COUNTY ENGINEER.
3. USE TYPE "0", "4" OR "6" JOINTS PER SEC. 208-2 OF STANDARD SPECIFICATIONS.

BREAKING INTO EXISTING BRICK OR PRECAST CONCRETE MANHOLE

COUNTY OF LOS ANGELES
DEPARTMENT OF PUBLIC WORKS

[Signature]
ASSISTANT DEPUTY

[Signature]
COUNTY ENGINEER

COUNTY ENGINEER
STANDARD

DATE: 3/80

DESIGN

S-13

[Signature] RCE
10403

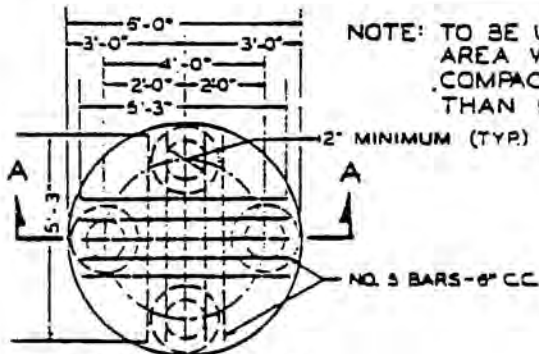

ROUND BASE

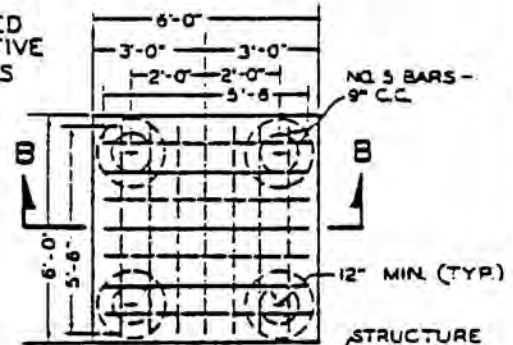

SQUARE BASE

NOTE: TO BE USED IN FILLED AREA WHERE RELATIVE COMPACTION IS LESS THAN 90 PERCENT.

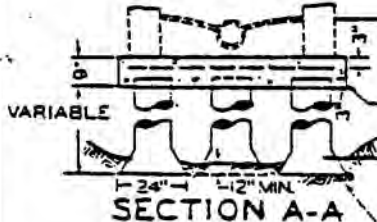

SECTION A-A

STRUCTURE ABOVE CAP STD. STRUCTURE S-3 OR S-36 WITHOUT BASE.
 CLASS 564 C 3000 CONCRETE CAP.
 CAST-IN-PLACE CIRCULAR CLASS 5C2500 CONCRETE PILES PER SEC. 205-3.3 OF STANDARD SPECIFICATIONS
 UNDISTURBED ORIGINAL GROUND AS DETERMINED BY THE COUNTY ENGINEER.

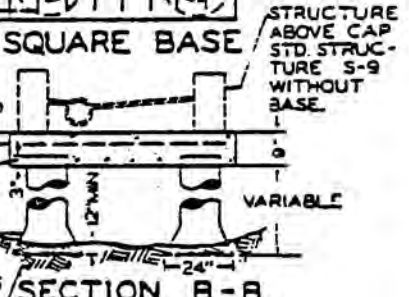

SECTION B-B

NOTE: SEPARATE DESIGN WILL BE REQUIRED IN EACH OF THE FOLLOWING CASES:

1. MANHOLE BASES LARGER THAN THOSE SHOWN.
2. MANHOLE DEPTH GREATER THAN TEN FEET.
3. PILE LENGTH GREATER THAN TWENTY FEET.

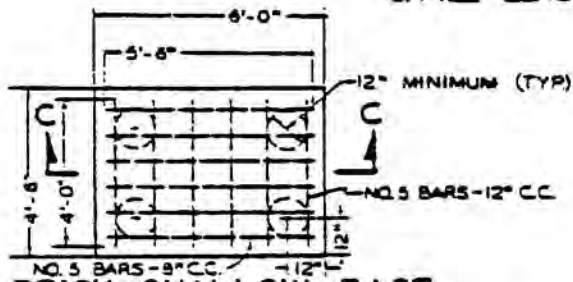

BRICK SHALLOW BASE

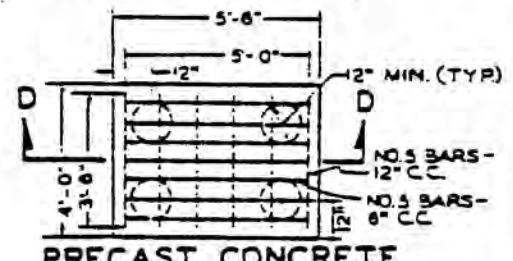

PRECAST CONCRETE SHALLOW BASE

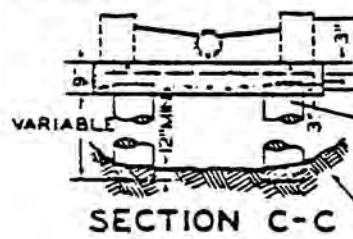

SECTION C-C

STRUCTURE ABOVE CAP STD. STRUCTURE S-7 WITHOUT BASE.
 CLASS 564 C 3000 CONCRETE CAP.
 CAST-IN-PLACE CIRCULAR CLASS 5C2500 CONCRETE PILES PER SEC. 205-3.3 OF STANDARD SPECIFICATIONS.
 UNDISTURBED ORIGINAL GROUND AS DETERMINED BY THE COUNTY ENGINEER.

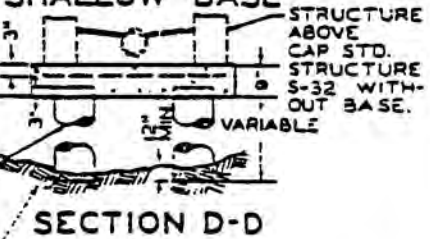

SECTION D-D

SPECIAL MANHOLE BASES

COUNTY OF LOS ANGELES
 DEPARTMENT OF PUBLIC WORKS

COUNTY ENGINEER
 STANDARD **S-14**
 DATE: 3/80

[Signature]
 ASSISTANT DEPUTY

[Signature]
 COUNTY ENGINEER

DESIGN *[Signature]* RCE
 10633

FOR USE WITH MANHOLES S-7 & S-32

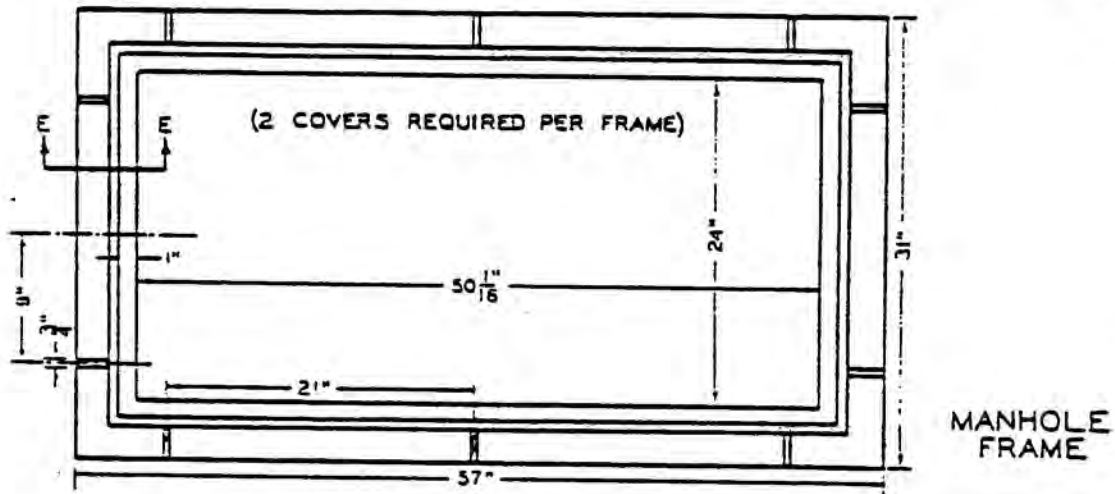
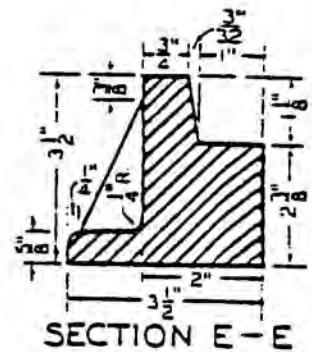
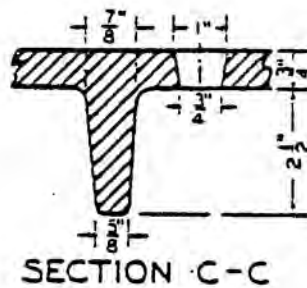
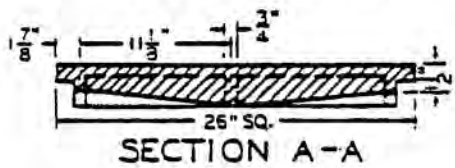
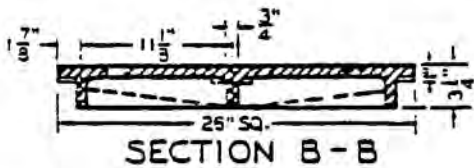
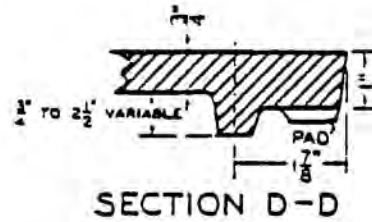
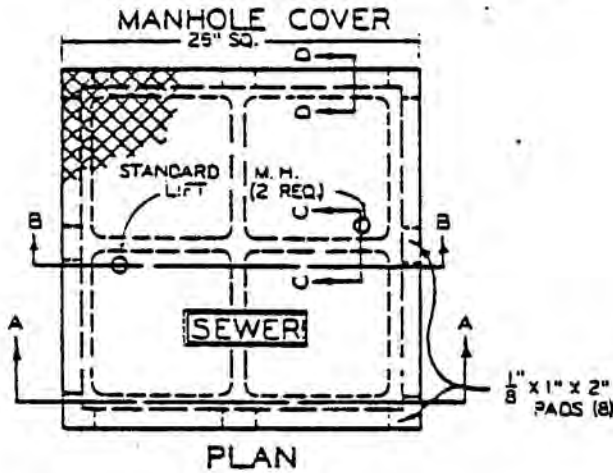

NOTE: USE CAST IRON PER SEC. 206-33 OF THE STANDARD SPECIFICATIONS.
 2 COVERS APPROX. WT. 195 LBS. EACH. 390 LBS.
 FRAME 270 LBS.
 TOTAL 660 LBS.

RECTANGULAR MANHOLE FRAME & COVERS

COUNTY OF LOS ANGELES
 DEPARTMENT OF PUBLIC WORKS

COUNTY ENGINEER
 STANDARD S-16

[Signature]
 ASSISTANT DEPUTY

[Signature]
 COUNTY ENGINEER

DATE: 3/80
 DESIGN *[Signature]* RCE
 12 10033

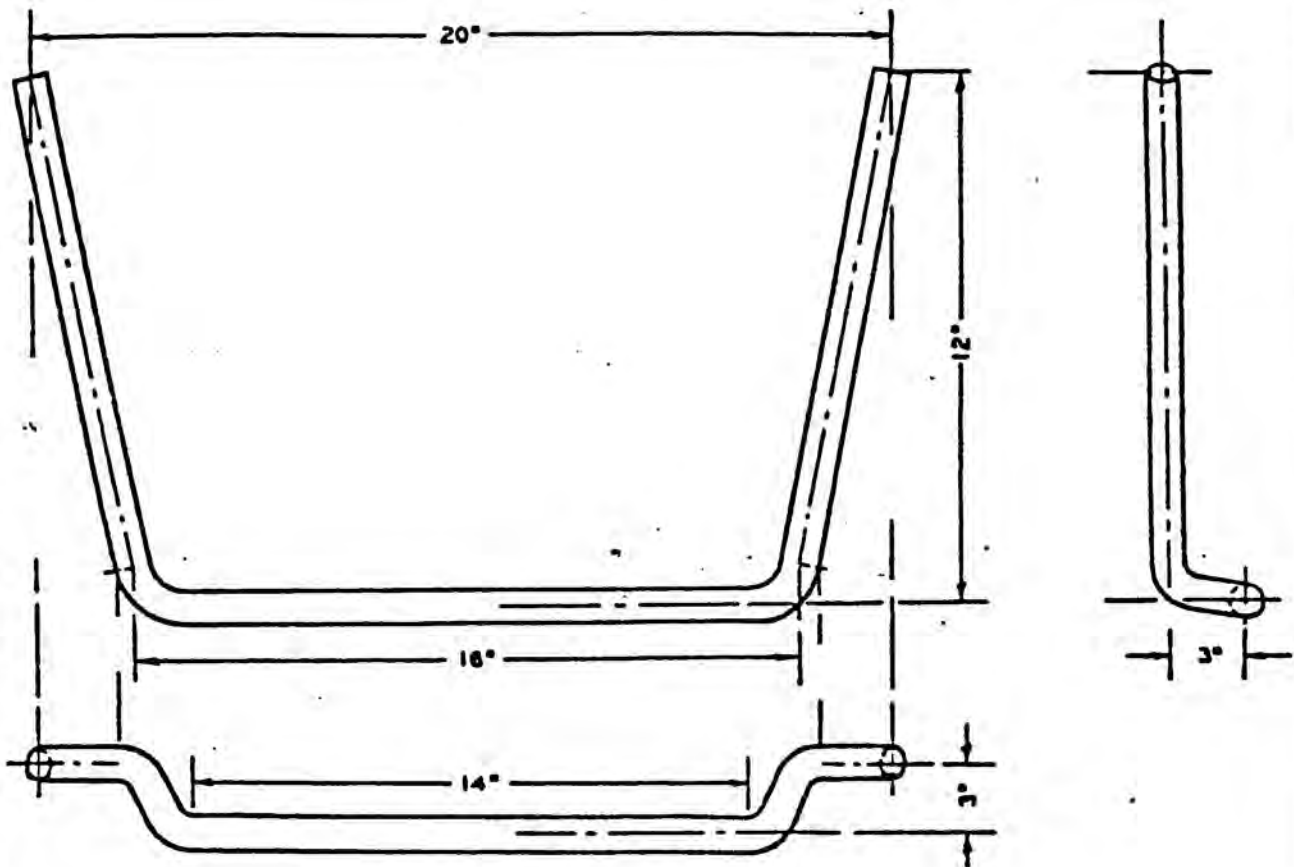

NOTE:

MATERIAL FOR THE STANDARD MANHOLE STEP SHALL BE ONE OF THE FOLLOWING:

1. 3/4" ϕ STEEL CONFORMING TO ASTM A15 OR A107 GALVANIZED AFTER FABRICATION IN ACCORDANCE WITH ASTM A123.
2. 3/4" ϕ ALUMINUM ALLOY 6061-T6 CONFORMING WITH ASTM B-211 OR B-221. THE PORTIONS OF THE ALUMINUM STEP TO BE EMBEDDED IN CONCRETE OR MORTAR SHALL BE GIVEN ONE COAT OF ZINC CHROMATE PRIMER. THE PRIMER SHALL BE ALLOWED TO DRY BEFORE THE STEP IS PLACED IN THE CONCRETE OR MORTAR.
3. 3/4" ϕ OR 3/4" SQUARE OR EQUIVALENT CROSS SECTIONAL AREA WROUGHT IRON CONFORMING TO ASTM A-207.

STANDARD MANHOLE STEP

COUNTY OF LOS ANGELES
DEPARTMENT OF PUBLIC WORKS

[Signature]
ASSISTANT DEPUTY

[Signature]
COUNTY ENGINEER

COUNTY ENGINEER
STANDARD

DATE: 3/80

S-17

DESIGN

[Signature] RCE
10727

NOTES:

1. CAST IRON SHALL BE FURNISHED PER SEC. 206-3.1 AND A.S.T.M. SPECIFICATIONS A-48, CLASS 30.
2. FLANGES OF CASTINGS TO BE MACHINE FACED.
3. CASTINGS SHALL BE DIPPED TWICE IN QUALITY HOT ASPHALTUM PAINT.
4. RUBBER GASKET SHALL BE FURNISHED PER SEC. 208-2.2.

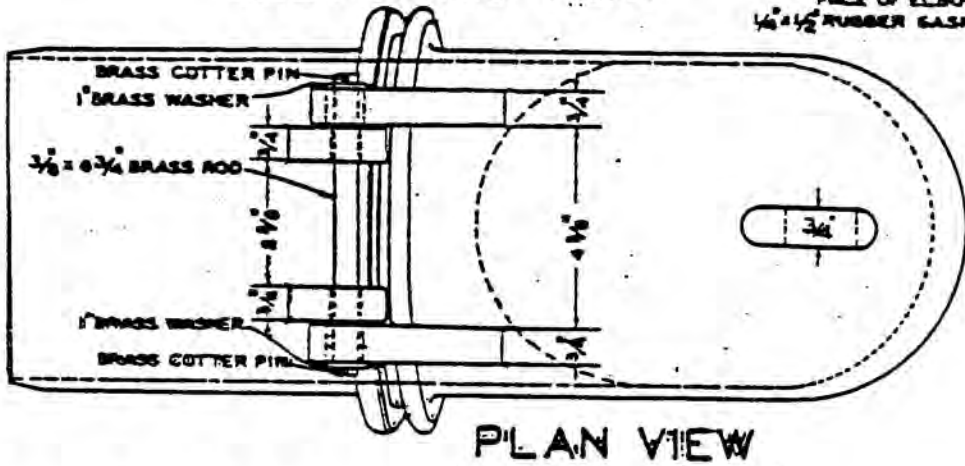
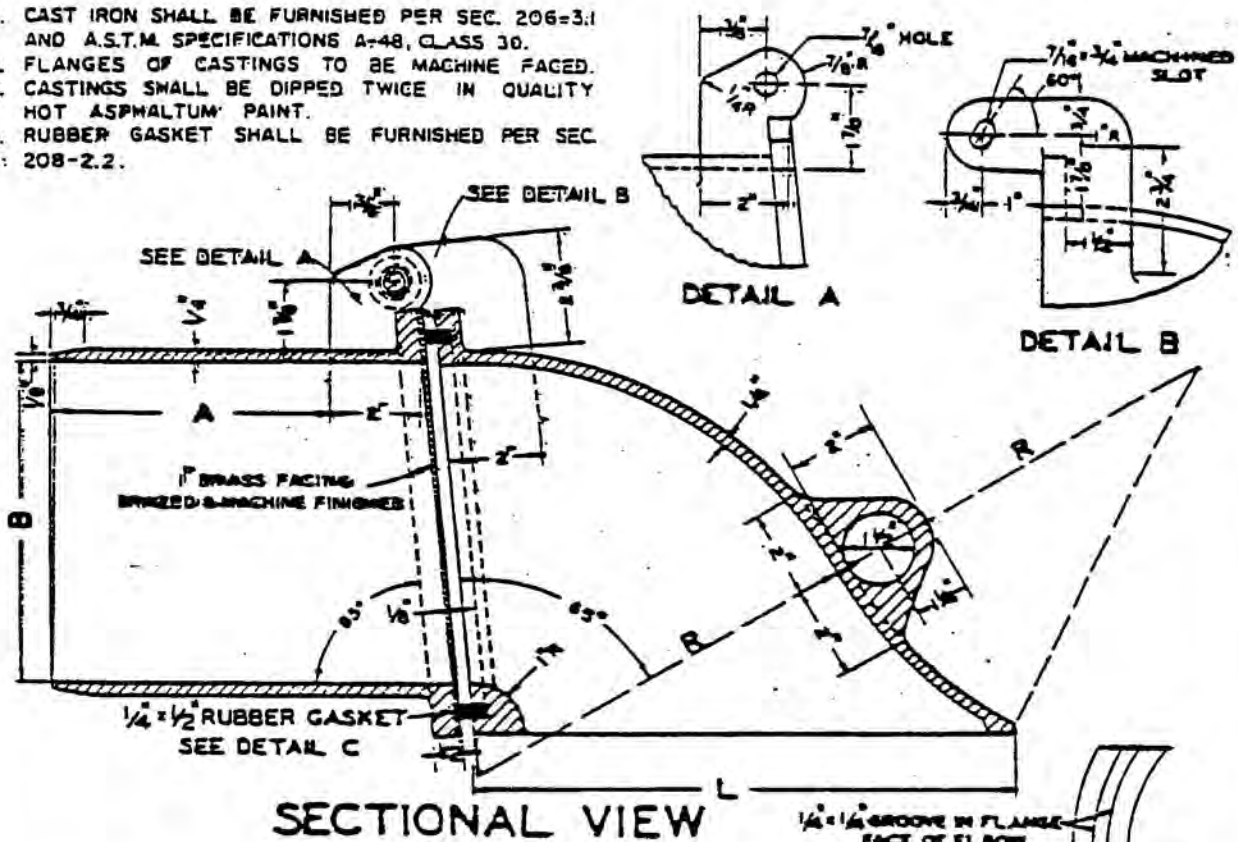

DIMENSIONS OF CASTING.				
INLET DIAM.	A	B	R.	L
10"	6"	9"	11"	14 3/4"
± 12"	7"	11"	13"	17 1/2"

± FOR GAS TRAPS 15" AND LARGER SEE S-19.

TRAP MANHOLE CASTING

COUNTY OF LOS ANGELES
DEPARTMENT OF PUBLIC WORKS

COUNTY ENGINEER
STANDARD **S-18**
DATE: 3/80

[Signature]
ASSISTANT DEPUTY

[Signature]
COUNT ENGINEER

DESIGN *[Signature]* RCE
11433

NOTE: STAINLESS STEEL SHALL BE A.I.S.I. TYPE 316 OR A.S.T.M. A 240-49 TYPE 316.

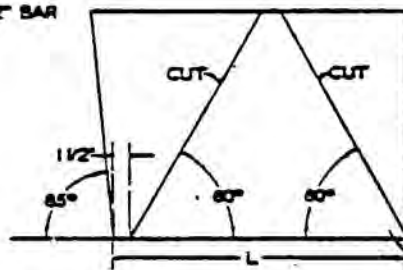
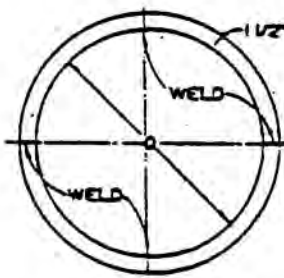
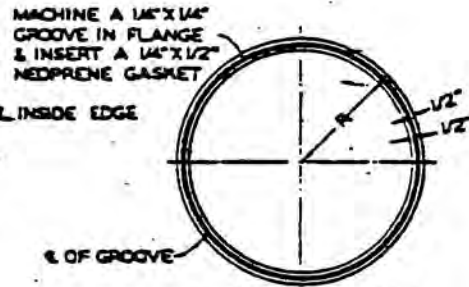
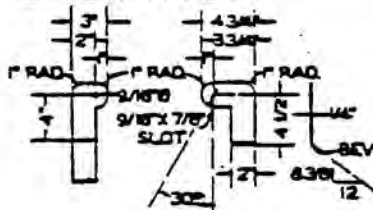
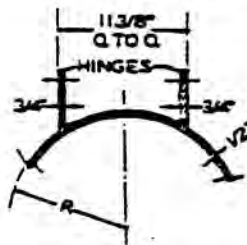
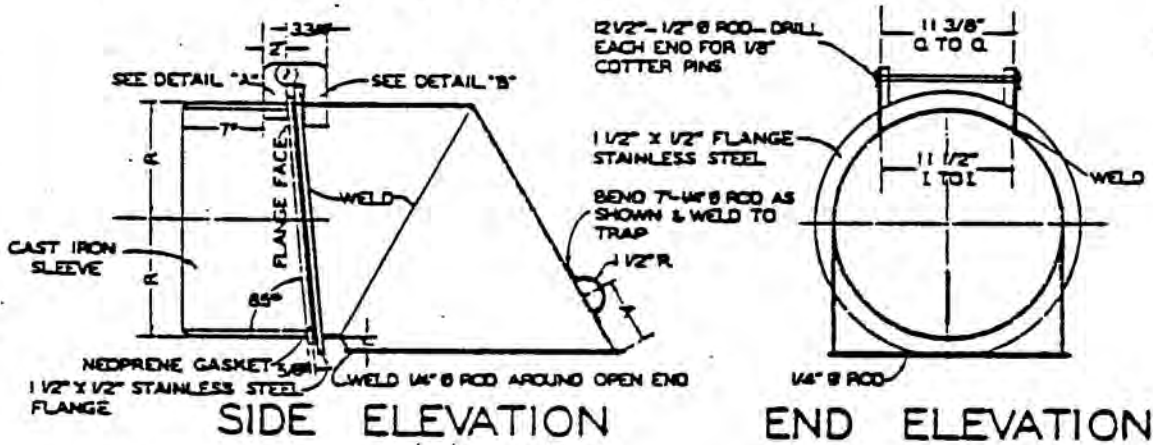

DIMENSIONS OF TRAP				
INLET DIAM.	A	D	R	L
15"	4"	14"	7 1/4"	19 1/16"
18"	5"	17"	8 3/4"	22 9/16"
21"	6"	20"	10 1/4"	26"

NOTE: - ALL MATERIAL TO BE STAINLESS STEEL EXCEPT AS NOTED.

LARGE GAS TRAP

COUNTY OF LOS ANGELES
DEPARTMENT OF PUBLIC WORKS

Assistant Deputy
ASSISTANT DEPUTY

County Engineer
COUNTY ENGINEER

COUNTY ENGINEER
STANDARD

DATE: 3/80

DESIGN

10663
RCE
10663

S-19

FOR USE IN NEW SUBDIVISIONS AND WHERE MANHOLE TOPS ARE LOWERED DUE TO STREET GRADE CHANGES OR PAVING OPERATIONS.

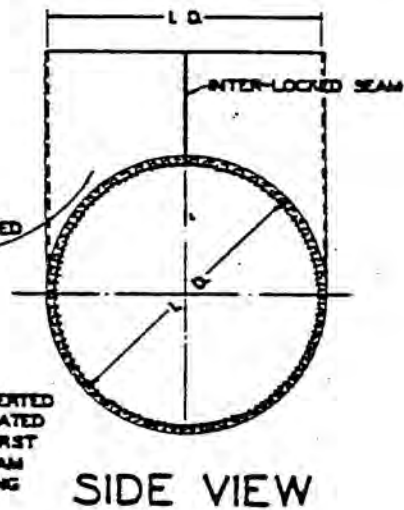
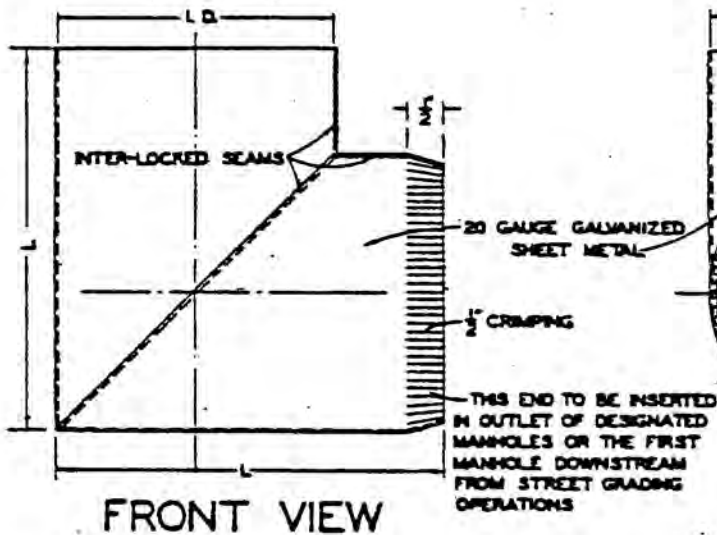
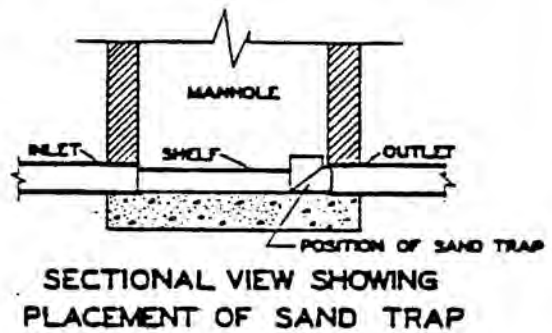
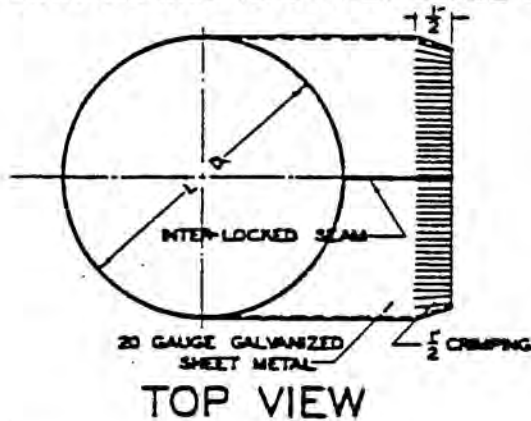

NOTES

1. SAND TRAP AS MANUFACTURED BY FLEXIBLE INC. OR APPROVED EQUAL MAY BE USED IN LIEU OF ABOVE.
2. GATES IN FLEXIBLE SAND TRAP SHALL BE SOLDERED OR WELDED IN CLOSED POSITION.

DIMENSIONS OF TRAP

L. D.	L	FLEXIBLE EQUIVALENT (SEE NOTES ABOVE)
8"	10 1/2"	ST-2
10"	12 1/2"	ST-3
12"	16"	ST-4
15"	18"	ST-6
18"	18"	ST-8

TEMPORARY SAND TRAP

COUNTY OF LOS ANGELES
DEPARTMENT OF PUBLIC WORKS

[Signature]
ASSISTANT DEPUTY

[Signature]
COUNTY ENGINEER

COUNTY ENGINEER
STANDARD

DATE: 3/80

S-20

DESIGN

[Signature] RCE
10663

("BEDDING" EXTENDS TO ONE FOOT OVER TOP OF PIPE PER SECTION 306-1.2.1 OF STANDARD SPECIFICATIONS)

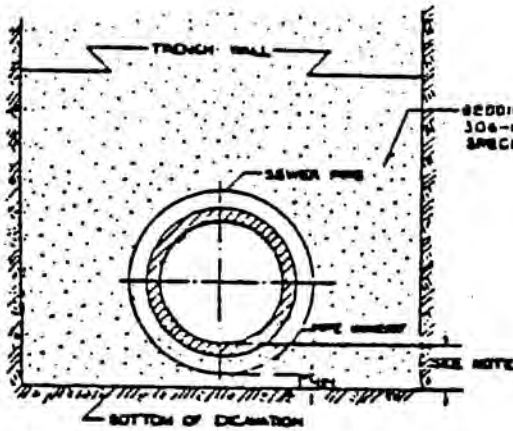

CASE I: NORMAL TRENCH

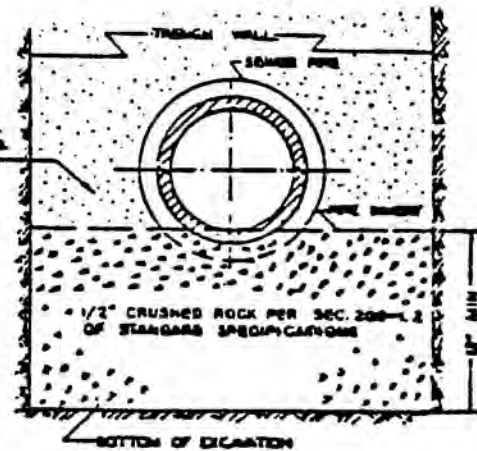

CASE II: WET, SPONGY GROUND

NOTE: BEDDING MATERIAL SUPPORTING THE PIPE OR CONDUIT SHALL BE GRAVEL, CRUSHED AGGREGATE OR OTHER GRANULAR MATERIAL AS APPROVED BY THE ENGINEER.

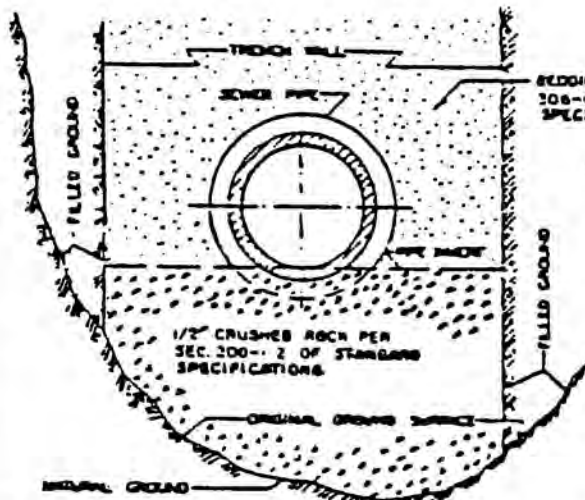

CASE III: FILLED GROUND
(LESS THAN 90% COMPACTION)

NOTE: WHERE NATURAL GROUND IS AT AN EXCESSIVE DEPTH BELOW THE HEIGHT OF THE PIPE, CONSTRUCTION SHALL COMPLY WITH THE SPEC. NOTED ON THE PLANS.

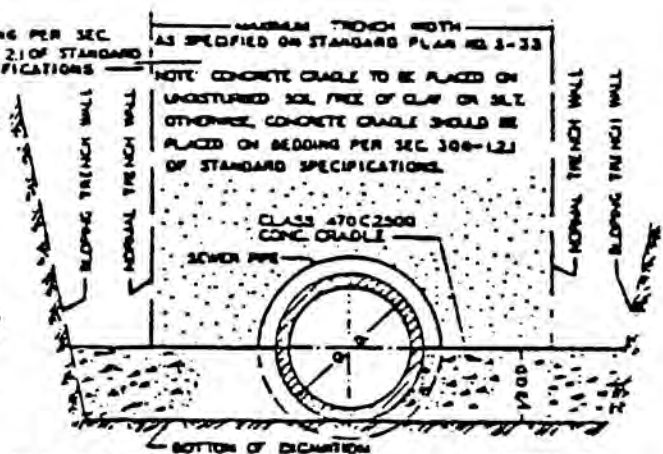

CASE IV: BOTTOM TRENCH WIDTH EXCEEDS THE WIDTH SPECIFIED ON STANDARD PLAN NO. S-33

BEDDING FOR SEWER PIPE

COUNTY OF LOS ANGELES
DEPARTMENT OF PUBLIC WORKS

[Signature]
ASSISTANT DEPUTY

[Signature]
COUNTY ENGINEER

COUNTY ENGINEER
STANDARD

DATE: 3/80

DESIGN

S-21

[Signature] RCE
12533

**ABS COMPOSITE (TRUSS) PIPE
 ABS SOLID WALL (SDR 23.5 ASTM D 2751) PIPE
 PVC SOLID WALL (SDR 35 ASTM D 3034) PIPE**

1. SHALLOW SEWERS, COVER OVER PIPE < 4 FEET:
 USE ENCASEMENT OR SPECIAL DESIGN APPROVED BY COUNTY ENGINEER.
2. ABS TRUSS OR SOLID WALL PIPE, DEPTH OF COVER 4-9 FEET:
 USE COUNTY ENGINEER STANDARD S-21.
3. ABS TRUSS OR SOLID WALL PIPE, DEPTH OF COVER 9-20 FEET:
 USE FIGURE 1 BELOW.
4. PVC PIPE, DEPTH OF COVER 4-17 FEET:
 USE FIGURE 1 BELOW.
5. ABS TRUSS OR SOLID WALL PIPE, 20 TO 30 FEET OR PVC PIPE, 17-30 FEET:
 USE ENCASEMENT PER STANDARD S-23, CASE II.
6. ABS OR PVC PIPE DEEPER THAN 30 FEET:
 SPECIAL DESIGN REQUIRED.

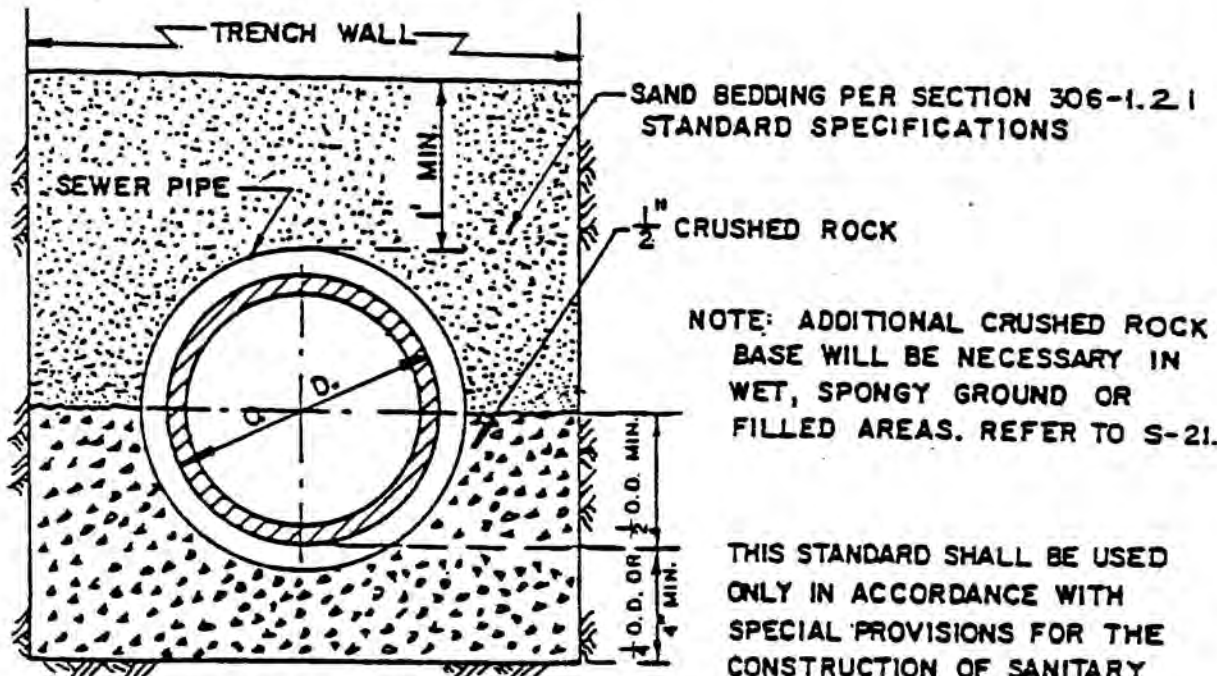

FIGURE 1

NOTE: ADDITIONAL CRUSHED ROCK BASE WILL BE NECESSARY IN WET, SPONGY GROUND OR FILLED AREAS. REFER TO S-21.

THIS STANDARD SHALL BE USED ONLY IN ACCORDANCE WITH SPECIAL PROVISIONS FOR THE CONSTRUCTION OF SANITARY SEWERS, PART IV, PLASTIC SEWER PIPE.

BEDDING FOR ABS & PVC SEWER PIPE

COUNTY OF LOS ANGELES DEPARTMENT OF PUBLIC WORKS <i>Assistant Deputy</i> ASSISTANT DEPUTY	COUNTY ENGINEER STANDARD S-21A DATE: 3/80 DESIGN <i>RCE</i> 10243
--	--

CASE I

WHERE CLEARANCE BETWEEN BOTTOM OF UNDERGROUND STRUCTURE AND TOP OF SEWER IS 0.5 TO 1.5 FEET
(IF WIDTH OF UNDERGROUND STRUCTURE IS 3 FT. OR LESS, ENCASE PER 3-23)

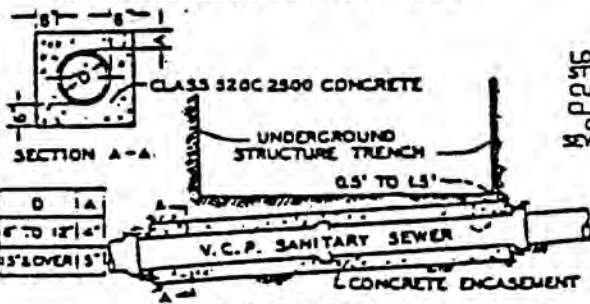

CASE II

WHERE CLEARANCE BETWEEN BOTTOM OF UNDERGROUND STRUCTURE AND TOP OF SEWER IS LESS THAN 0.5 FEET

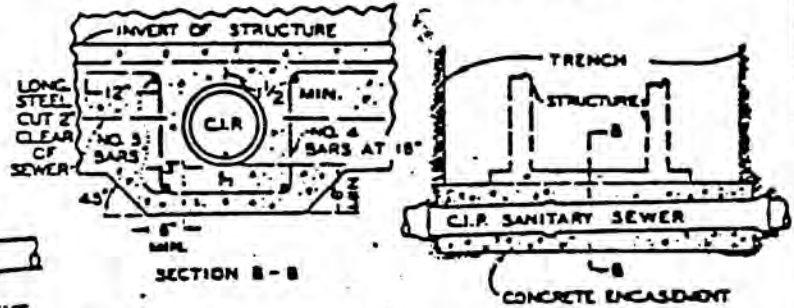

CASE III

WHERE UNDERGROUND STRUCTURE IS CONSTRUCTED UNDER SEWER - PIPE SUPPORT TO BE CONSTRUCTED UNDER PIPE JOINT WHERE CROSSING REQUIRES MORE THAN ONE LENGTH OF C.I.P.

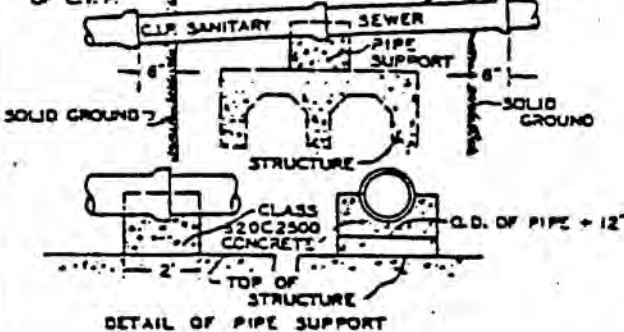

CASE IV

CONCRETE SUPPORT WALL

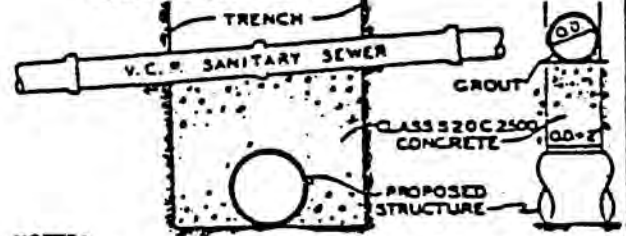

NOTES:

1. SUPPORT WALL SHALL HAVE A FIRM BEARING ON THE SUBGRADE AND AGAINST THE SIDES OF THE EXCAVATION.
2. WALL SHALL BE AT LEAST 2" FREE AND CLEAR OF ANY GAS OR WATER MAIN OR OTHER CONDUIT OR DUCT.
3. WHENEVER SO DIRECTED BY ENGINEER, THE CONTRACTOR SHALL PROVIDE SUITABLE OPENING IN THE WALL TO PREVENT UNEQUAL PRESSURE RESULTING FROM FLOODING THE SAG-FILL THE VOLUME OF THE PERCED OPENING SHALL NOT EXCEED 1/3 THE VOLUME OF THE SUPPORTING WALL.

CASE V

CONCRETE BEAM

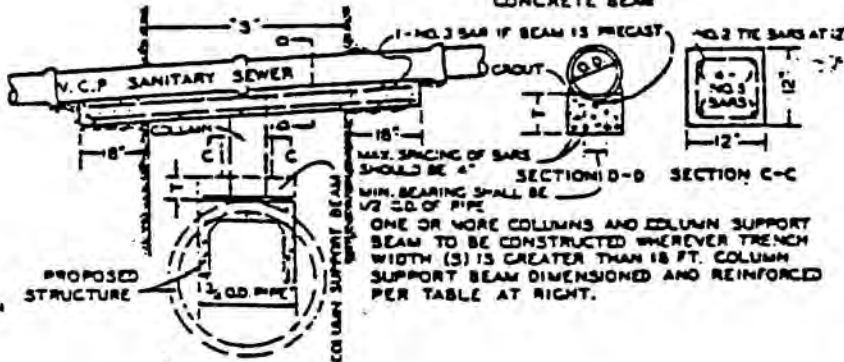

DIMENSIONS OF REINFORCED CONCRETE BEAM AND COLUMN SUPPORT BEAM

"S" (FT.)	DEPTH OF COVER			
	0' TO 8'-0"	8'-0" TO 16'-0"	16'-0" TO 20'-0"	20'-0" TO 25'-0"
4	3"	4"	4"	5"
5	3"	4"	5"	5"
6	3 1/2"	5"	5 1/2"	6"
7	3"	5 1/2"	6"	6"
8	3 1/2"	5 1/2"	6"	7"
9	4"	6"	6 1/2"	7"
10	4 1/2"	6 1/2"	7"	7"
11	4 1/2"	6 1/2"	7 1/2"	8"
12	5 1/2"	7"	7"	8"
13	5 1/2"	7 1/2"	7"	
14	5 1/2"	7 1/2"	8"	
15	6 1/2"	7 1/2"	8"	
16	6 1/2"	7"		
17	6 1/2"	8"		
18	6 1/2"	8"		

GENERAL NOTES

1. EXTEND BOTH ENDS OF ENCASEMENT TO A POINT ONE INCH SHORT OF FIRST PIPE JOINT BEYOND LOCATIONS SPECIFIED ON PLANS. (SEE 3-23)
2. WHERE CLEARANCE BETWEEN BOTTOM OF STRUCTURE AND TOP OF SEWER IS LESS THAN 0.5 FEET, THE ENCASEMENT SHALL BE POURED MONOLITHIC WITH THE BASE OF THE UNDERGROUND STRUCTURE.
3. IF BEAMS OF CASE V ARE PRECAST, 18 INCHES AT ENDS OF BEAMS SHALL BE BEDDED IN CLASS 320C 2500 CONCRETE.
4. GROUT SHALL BE PLACED BETWEEN TOP OF BEAMS AND BOTTOM OF PIPE TO GIVE BEARING AS PER SECTION D-D ABOVE. BEAM WIDTH TO BE G.D. + 2".
5. ALL REINFORCING STEEL SHALL BE MINIMUM 2" CLEAR FROM SIDES, EDGES, AND BOTTOMS OF BEAMS AND COLUMNS.

SPECIAL SUPPORT AND PROTECTION

COUNTY OF LOS ANGELES
DEPARTMENT OF PUBLIC WORKS

Assistant Deputy
ASSISTANT DEPUTY

County Engineer
COUNTY ENGINEER

COUNTY ENGINEER
STANDARD

DATE: 3/80

S-22

DESIGN

Design
RCE
2/10/83

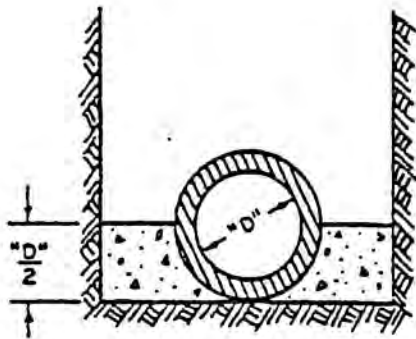

CASE I - CONCRETE CRADLE

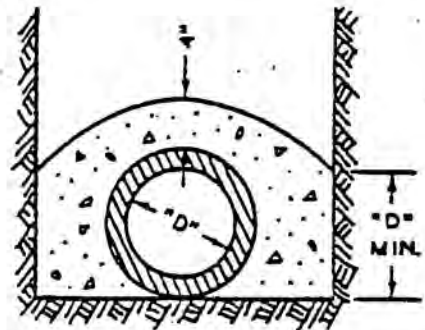

CASE II - CONCRETE ENCASEMENT

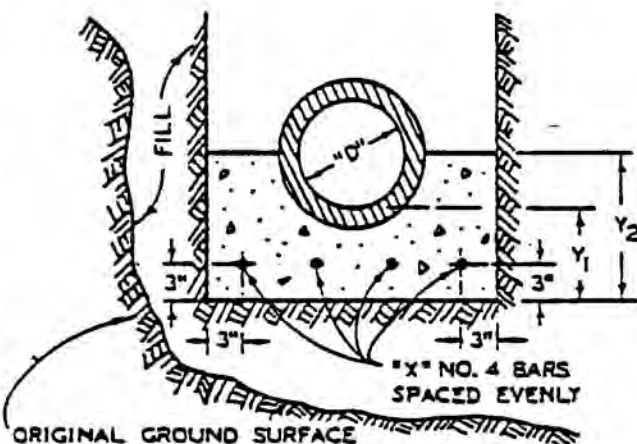

CASE III - SPECIAL CRADLE

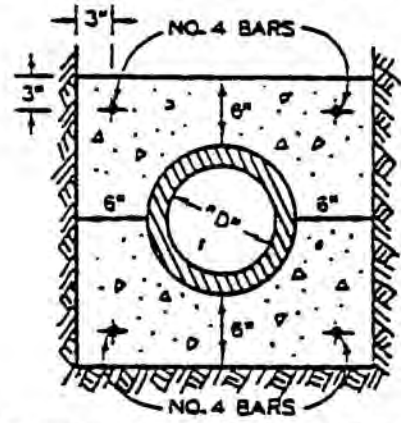

CASE IV - SPECIAL ENCASEMENT

SCHEDULE OF DIMENSIONS AND REINFORCING BARS FOR SPECIAL CRADLE CASE III

"D" (DIAMETER)	"X" NO. OF NO. 4 BARS	THICKNESS	
		Y ₁	Y ₂
6"	2	4"	8"
8"	4	5"	10"
10"	4	6"	12"
12"	4	7"	15"
15"	5	9"	19"
18"	5	10"	22"
21"	6	12"	26"
24"	6	13"	28"

GENERAL NOTES:

1. EXTEND BOTH ENDS OF CRADLE OR ENCASEMENT TO A POINT ONE INCH SHORT OF FIRST PIPE JOINT BEYOND LOCATIONS SPECIFIED ON PLAN.

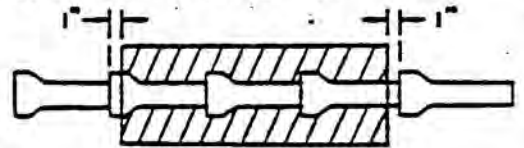

PLAN VIEW

2. APPLY FORM OIL, THIN PLASTIC SHEET, OR OTHER ACCEPTABLE MATERIAL TO PIPE, TO PREVENT BOND BETWEEN PIPE AND CONCRETE.
3. USE CLASS 470C2500 CONCRETE FOR ALL CASES.

CRADLING AND ENCASEMENT

COUNTY OF LOS ANGELES
DEPARTMENT OF PUBLIC WORKS

COUNTY ENGINEER
STANDARD S-23

[Signature]
ASSISTANT DEPUTY

[Signature]
COUNTY ENGINEER

DATE: 3/80
DESIGN
[Signature] RCE
10643

TO BE USED WHEN SEWER GRADE IS GREATER THAN 30%, OR WHEN DESIGNATED ON THE PLAN.

THIS STANDARD APPLIES TO 8 INCH THROUGH 12 INCH PIPE SIZES. LARGER SIZE PIPES WILL REQUIRE A SPECIAL DESIGN.

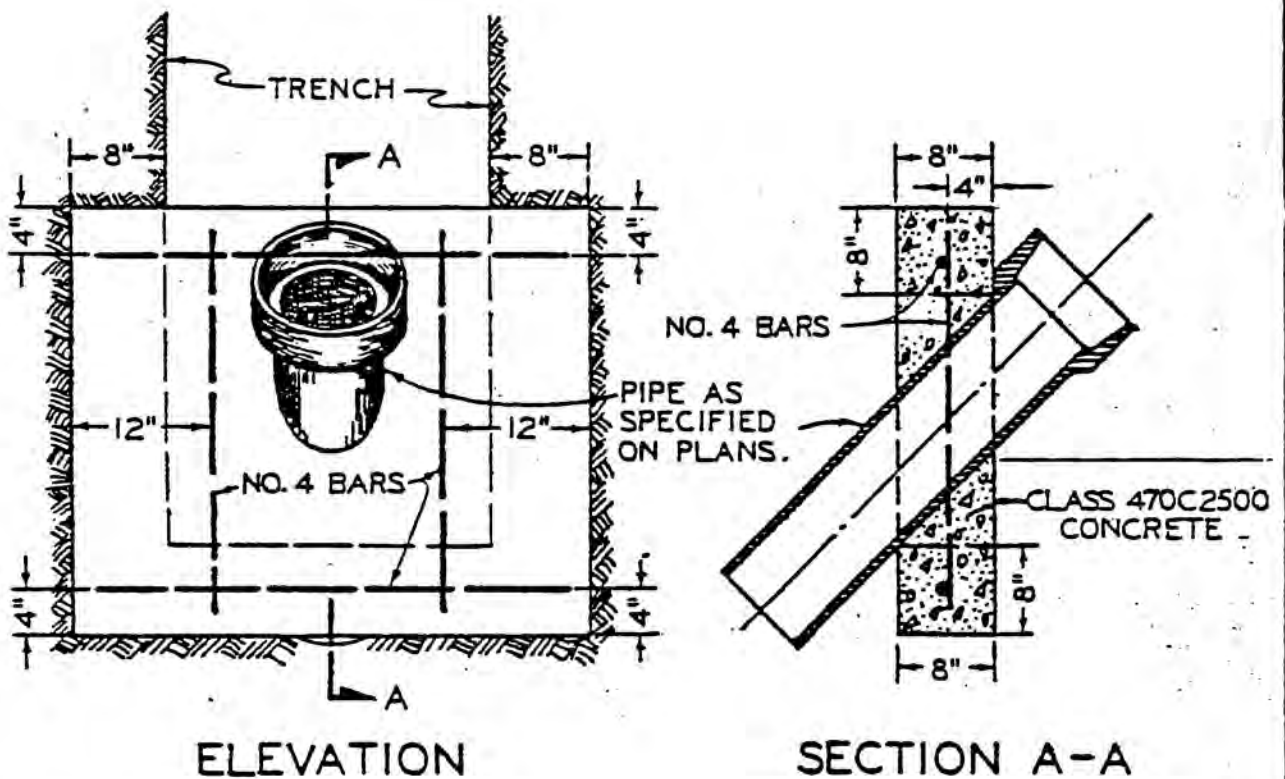

ANCHOR BLOCK

COUNTY OF LOS ANGELES
DEPARTMENT OF PUBLIC WORKS

[Signature]
ASSISTANT DEPUTY

[Signature]
COUNTY ENGINEER

COUNTY ENGINEER
STANDARD

S-24

DATE: 3/80

DESIGN

[Signature] RCE
10443

CASE I

SPECIAL HOUSE LATERAL UNDER STRUCTURE

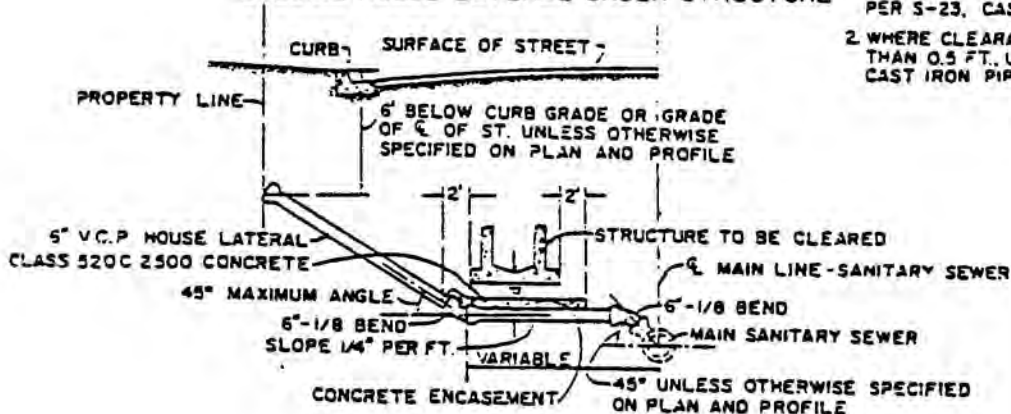

- NOTES:
1. WHERE CLEARANCE "d" IS 0.5 TO 1.5 FT., USE V.C.P. AND ENCASE PER S-23, CASE II.
 2. WHERE CLEARANCE "d" IS LESS THAN 0.5 FT., USE CLASS 150 CAST IRON PIPE.

CASE II

SPECIAL HOUSE LATERAL OVER STRUCTURE

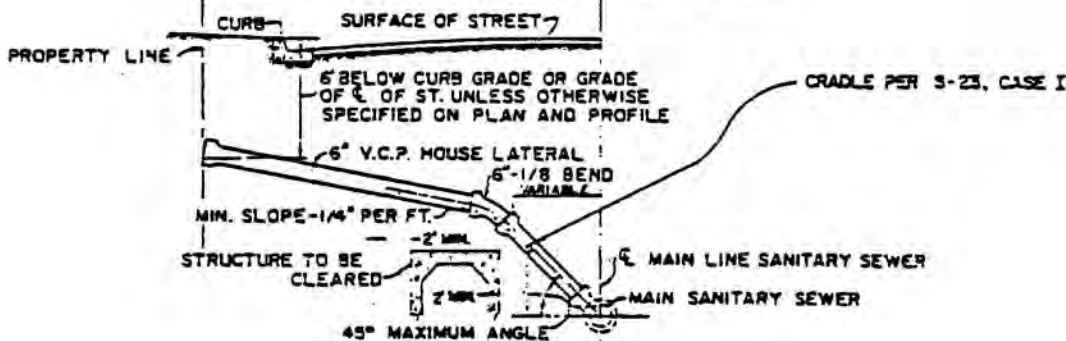

CASE III

SPECIAL HOUSE LATERAL WITH CHIMNEY

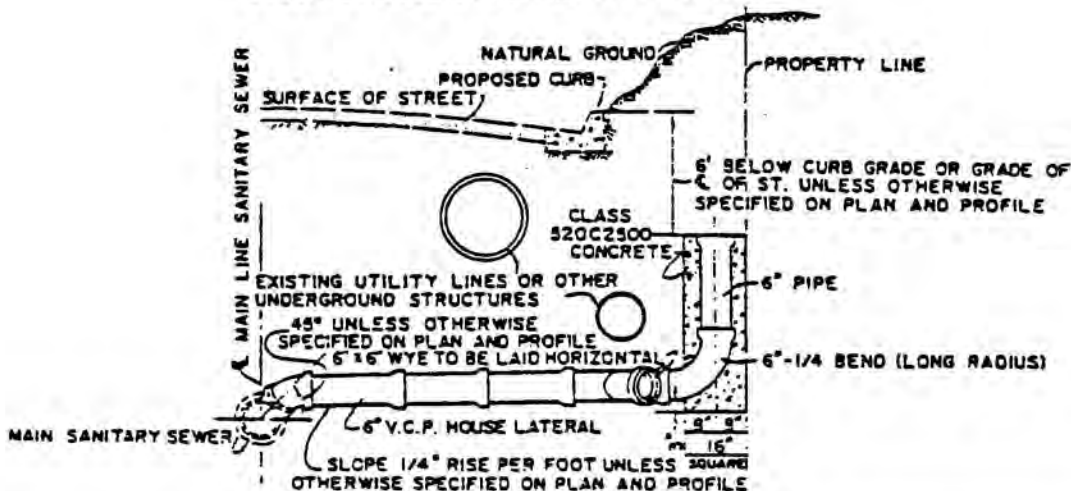

SPECIAL HOUSE LATERALS

COUNTY OF LOS ANGELES
DEPARTMENT OF PUBLIC WORKS

COUNTY ENGINEER
STANDARD

DATE: 3/80

S-25

DESIGN

PCB
12/12/13

ASSISTANT DEPUTY

COUNTY ENGINEER

WYE BRANCHES TO BE SUPPORTED AS SHOWN IN ALL CASES

TEE BRANCHES TO BE SUPPORTED AS SHOWN IF LAID FLAT

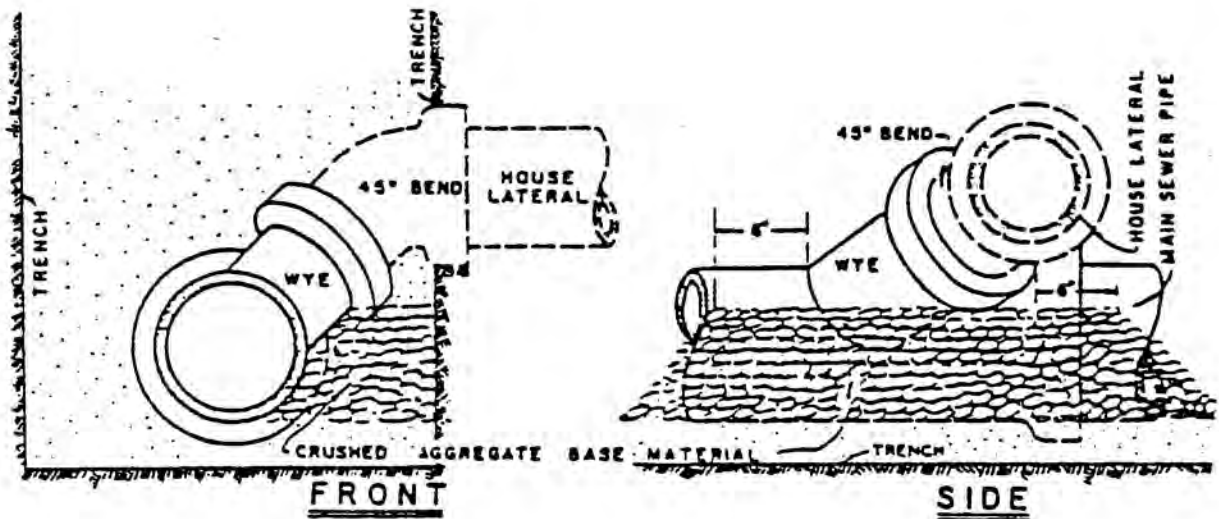
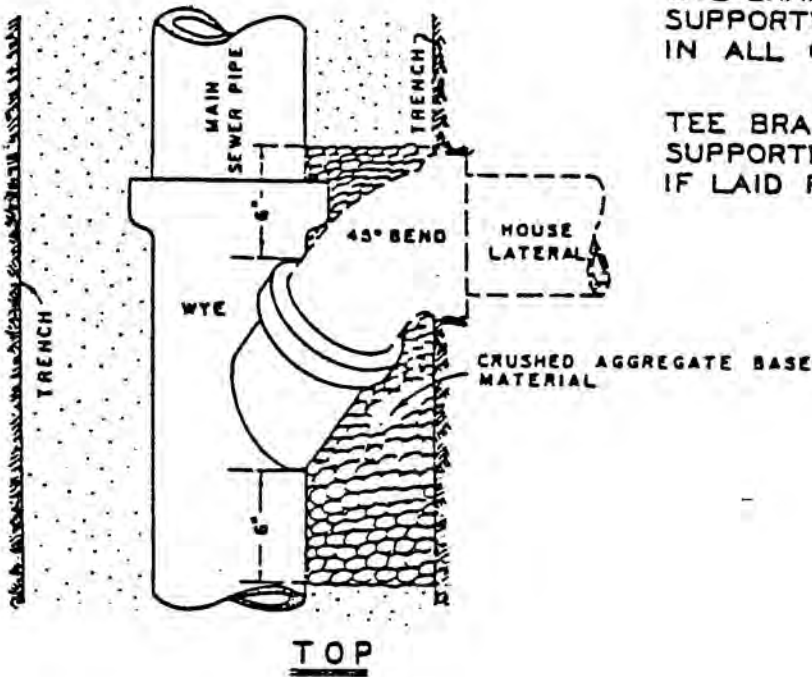

AGGREGATE BASE MATERIAL TO BE "1/2" CRUSHED" ROCK PER SEC. 200-1.2 OF THE STANDARD SPECIFICATIONS

WYE OR TEE SUPPORT

COUNTY OF LOS ANGELES
DEPARTMENT OF PUBLIC WORKS

COUNTY ENGINEER
STANDARD

DATE: 3/80

S-26

DESIGN

RCE
10653

ASSISTANT DEPUTY

COUNTY ENGINEER

BARs ARE TO BE LEFT VERTICAL AND BENT IN PLACE WHEN BEAM IS FORMED.

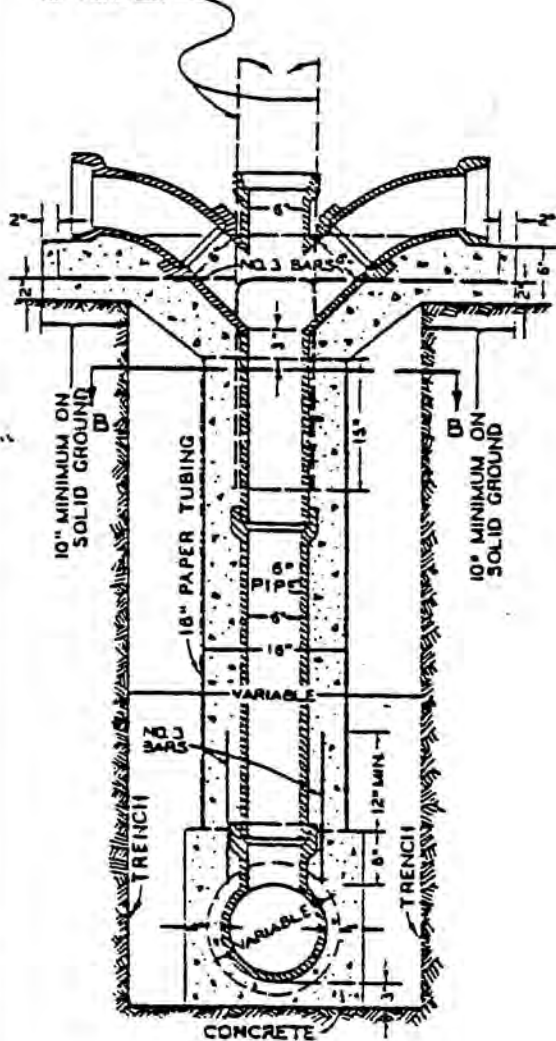

SECTION A-A

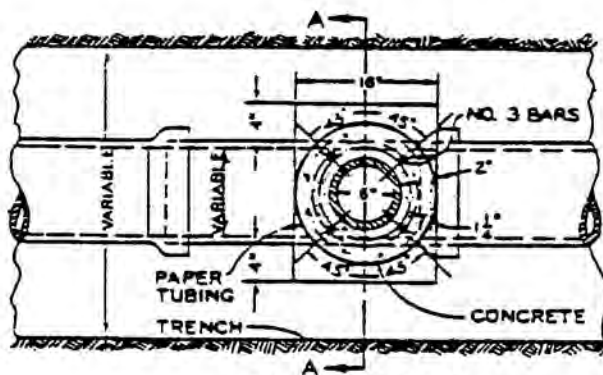

SECTION B-B

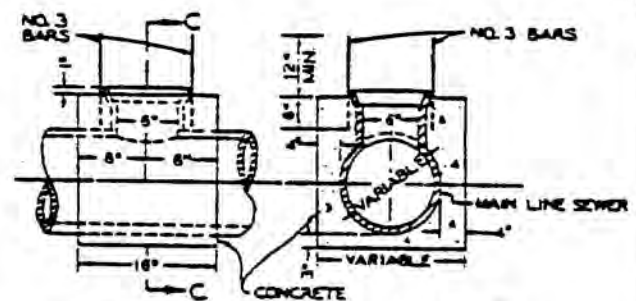

ELEVATION SECTION C-C
CHIMNEY BASE

NOTES

1. THE UPPER END OF THE CHIMNEY PIPE SHALL BE AT LEAST 8 FEET BELOW THE GRADE OF THE LOWER CURB.
2. THE CHIMNEY PIPE SHALL BE VITRIFIED CLAY PIPE WITH MECHANICAL COMPRESSION JOINTS.
3. NO CONNECTION SHALL BE MADE DIRECTLY TO TOP OF CHIMNEY PIPE.
4. WHERE ONE HOUSE LATERAL IS TO BE JOINED TO THE CHIMNEY PIPE, USE A SINGLE "Y" AND FACE "Y" TOWARDS PROPERTY TO BE SERVED.
5. WHERE TWO OR MORE HOUSE LATERALS ARE TO BE JOINED TO THE CHIMNEY PIPE, INSTALL "Y" BRANCHES AS FOLLOWS:
 - a. FOR TWO HOUSE LATERALS, ONE SERVING EACH SIDE OF STREET, USE A DOUBLE "Y" BRANCH.
 - b. FOR TWO HOUSE LATERALS SERVING THE SAME SIDE OF THE STREET, USE TWO SINGLE "Y" STACKED WITH BRANCHES FACING THE PROPERTIES SERVED.
 - c. FOR THREE OR FOUR HOUSE LATERALS, USE TWO DOUBLE "Y" BRANCHES OR ONE DOUBLE AND ONE SINGLE "Y" BRANCH STACKED.
6. EACH DOUBLE OR SINGLE "Y" BRANCH AND EIGHTH BEND SHALL BE SUPPORTED BY A CONCRETE BEAM AS SHOWN.
7. FOR CHIMNEY BASE, 6" TEE BRANCH OR SADDLE SHALL BE INSTALLED VERTICALLY ON TOP OF THE MAIN LINE SEWER AS SHOWN HEREON OR IN ACCORDANCE WITH GENERAL NOTES PER S-28. THE CHIMNEY BASE MUST BE POURED AND SET WITH DOWELS AS SHOWN HEREON 24 HOURS BEFORE THE CHIMNEY CONCRETE IS POURED.
8. ALL CONCRETE SHOWN HEREON SHALL BE CLASS 470 C2500.

CHIMNEY PIPE AND BASE

COUNTY OF LOS ANGELES
DEPARTMENT OF PUBLIC WORKS

COUNTY ENGINEER
STANDARD

DATE: 3/80

S-27

DESIGN

RCE
10223

[Signature]
ASSISTANT DEPUTY

[Signature]
COUNTY ENGINEER

TEE SADDLE INSTALLATION

WYE SADDLE INSTALLATION

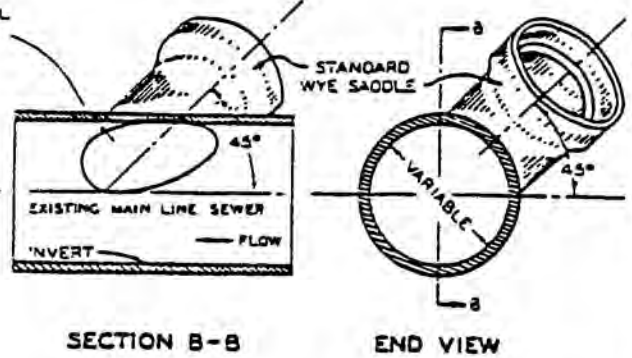
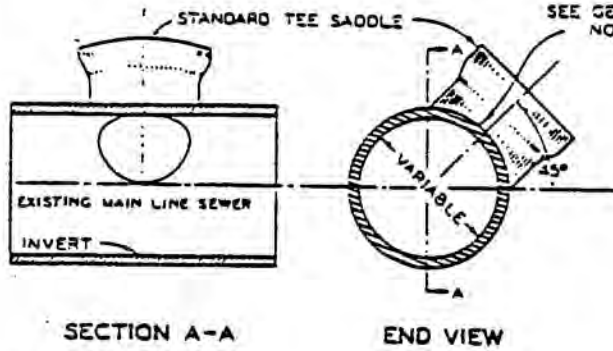

TEE OR WYE SADDLE JOINTS AND SUPPORT

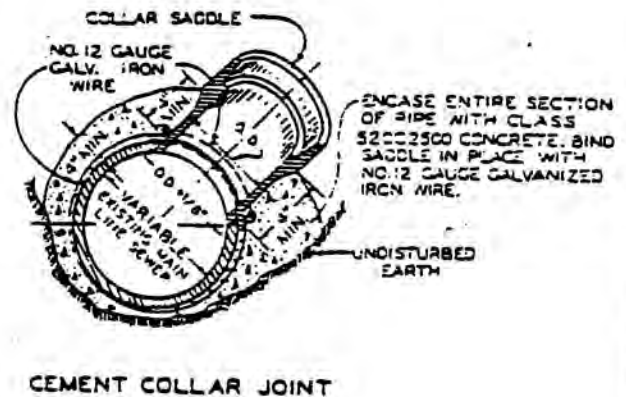
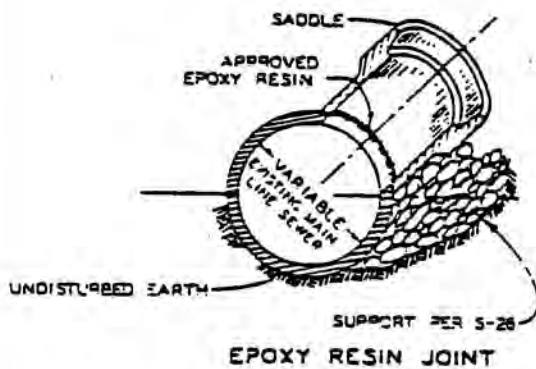

GENERAL NOTES

1. A WYE OR TEE SADDLE SHALL BE INSTALLED BY CUTTING A NEAT HOLE CONFORMING TO THE INSIDE DIAMETER OF THE SADDLE WHEN USING A SADDLE WITHOUT COLLAR AS SHOWN IN EPOXY RESIN JOINT DETAIL. WHEN USING A SADDLE WITH COLLAR THE DIAMETER OF THE HOLE SHALL BE OUTSIDE DIAMETER PLUS 1/8" AS SHOWN IN CEMENT COLLAR JOINT DETAIL.
2. BROKEN PIECES FROM CUTTING OF THE MAIN LINE SEWER MUST BE EXTRACTED CAREFULLY PRIOR TO PLACEMENT OF THE SADDLE.
3. THE SADDLE SHALL BE CEMENTED INTO PLACE USING CLASS "D" CEMENT MORTAR PER SECTION 201-51 OR OTHER CEMENTING AGENT APPROVED BY THE COUNTY ENGINEER. THE SADDLE SHALL BE HELD SECURELY IN PLACE WHILE THE CEMENT OR OTHER APPROVED CEMENTING AGENT SETS. THE INSIDE OF THE JOINT BETWEEN PIPE AND SADDLE SHALL BE FILLED WITH CEMENTING MATERIAL AND NEATLY ROUNDED.
4. FOR INSTALLATION OF TEE SADDLE FOR CHIMNEY BASE REFER TO GENERAL NOTES ABOVE AND S-27, NOTE 7.

SADDLES FOR HOUSE LATERALS

COUNTY OF LOS ANGELES
DEPARTMENT OF PUBLIC WORKS

COUNTY ENGINEER
STANDARD

DATE: 3/80 S-28

DESIGN

RCE
10643

[Signature]
ASSISTANT DEPUTY

[Signature]
COUNTY ENGINEER

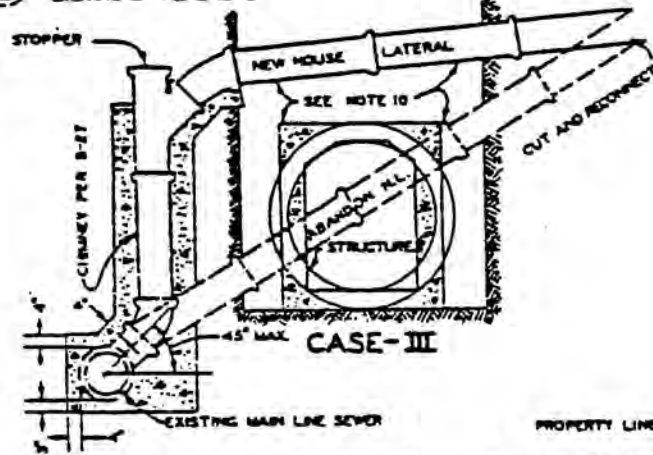
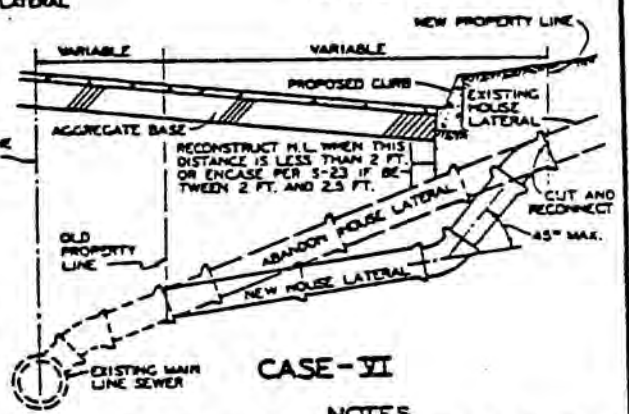
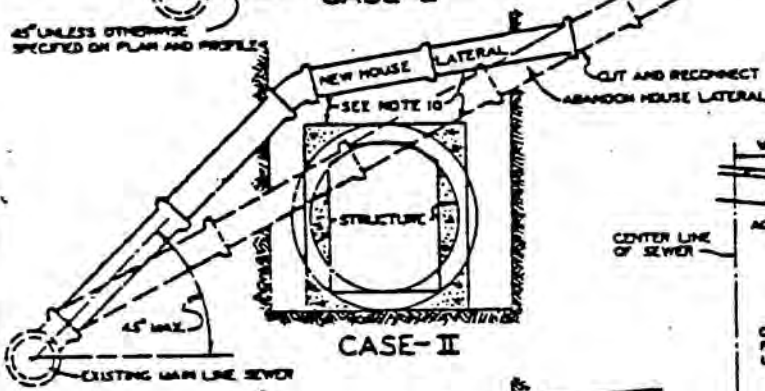
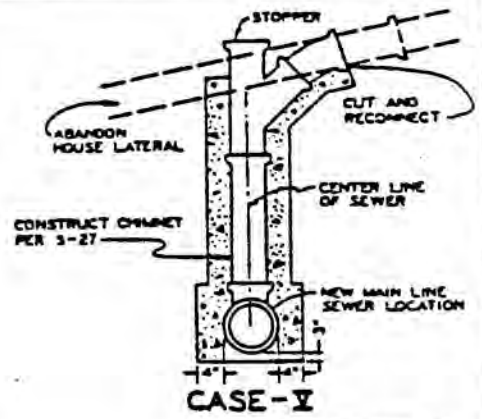
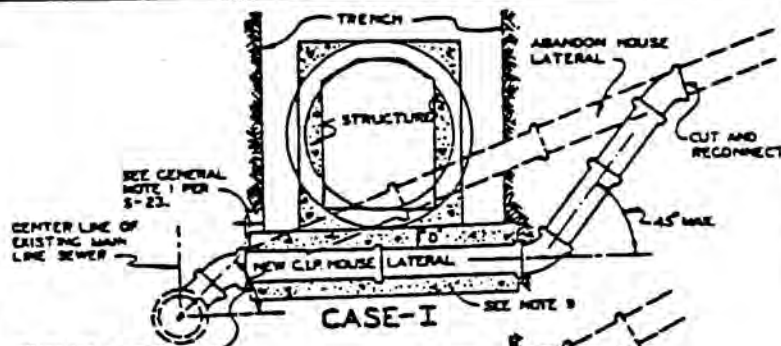

CASE-VI

NOTES

1. HOUSE LATERALS FOR CASES II, III, IV, AND V SHALL BE RECONSTRUCTED OF VITRIFIED CLAY PIPE WITH MECHANICAL COMPRESSION JOINTS UNLESS OTHERWISE SPECIFIED ON THE PLANS.
2. HOUSE LATERALS FOR CASES I AND VI SHALL BE CAST IRON PIPE WITH RUBBER GASKET SLIP-ON JOINTS UNLESS OTHERWISE SPECIFIED ON THE PLANS.
3. THE MINIMUM SLOPE FOR HOUSE LATERALS SHALL BE 1/4 INCH PER FOOT.
4. "Y'S" OR "T'S" MAY BE LAID "FLAT" UPON APPROVAL OF THE COUNTY ENGINEER.
5. WHERE ENCASEMENT IS SPECIFIED FOR AN EXISTING HOUSE LATERAL BUT FIELD INSPECTION DURING CONSTRUCTION REVEALS THAT THERE IS ACTUALLY LESS THAN TWO FEET OF CLEARANCE BETWEEN THE PROPOSED AGGREGATE BASE OF THE STREET AND THE TOP OF THE EXISTING HOUSE LATERAL, SUCH HOUSE LATERAL SHALL BE RECONSTRUCTED PER CASE - III.
6. SADDLES MAY BE USED WHERE NECESSARY AND SHALL BE INSTALLED PER S-28.
7. ALL CEMENT CONCRETE USED FOR ENCASEMENT AND CHIMNEY CONSTRUCTION SHALL BE OF CLASS 470 C2800.
8. WHEN V.C.P. HOUSE LATERALS ARE TO BE SUPPORTED PER S-22, AND IT IS DETERMINED THAT THERE IS INSUFFICIENT COVER OVER THE PIPE, ENCASE PER S-23, CASE II AND INCREASE THE SIZE OF THE SUPPORT.
9. WHERE CLEARANCE "D" IS MORE THAN 0.5 FT. ENCASEMENT IS NOT REQUIRED. WHERE CLEARANCE "D" IS LESS THAN 0.5 FT., ENCASE PER S-22, CASE II.
10. SEE S-22, CASES II, III OR IV FOR SPECIAL SUPPORT AND PROTECTION.

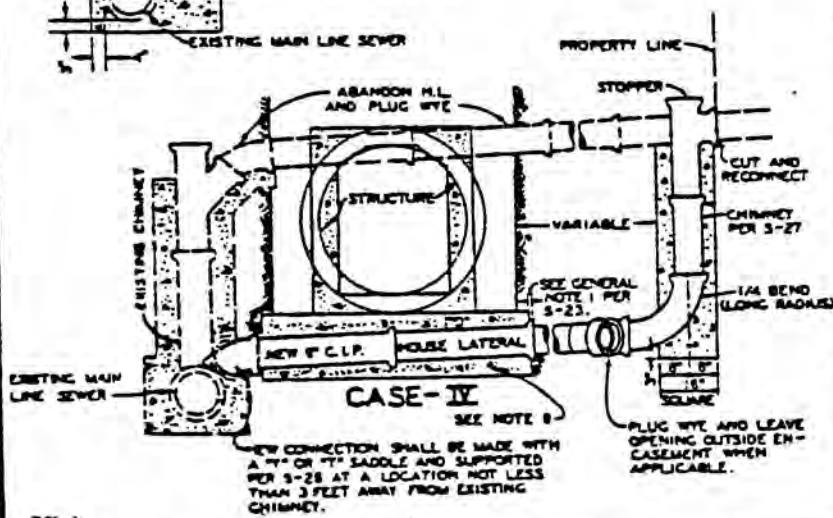

RECONSTRUCTION OF SANITARY SEWER HOUSE LATERALS

COUNTY OF LOS ANGELES
DEPARTMENT OF PUBLIC WORKS

COUNTY ENGINEER
STANDARD **S-29**
DATE: 3/80

Richard J. ...
ASSISTANT DEPUTY

Stephen J. ...
COUNTY ENGINEER

DESIGN
... RCE
10663

TO BE USED IN EASEMENTS WHERE THE SURFACE GRADE IS GREATER THAN 30% OR WHEN DESIGNATED ON THE PLAN.

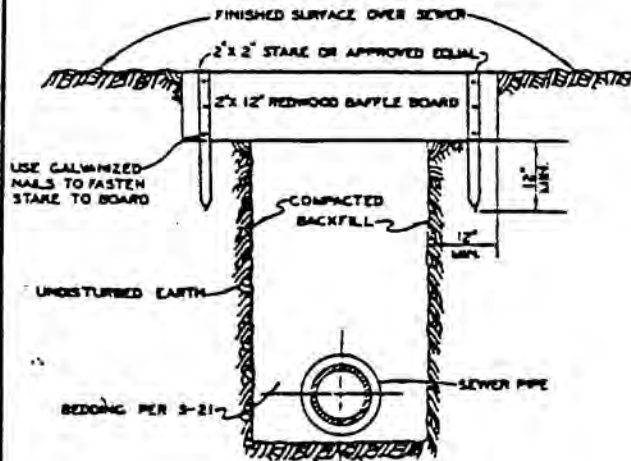

**CASE I
BAFFLE BOARD**

1. TO BE USED WHEN TRENCH IS EXCAVATED IN UNDISTURBED NATURAL SOIL, UNLESS CASE II APPLIES.
2. THE BAFFLE BOARDS SHALL BE SPACED SO THAT THE TOP OF THE LOWER BOARD IS LEVEL WITH THE BOTTOM OF THE NEXT HIGHER BOARD.
3. THE UPPER ONE FOOT LAYER OF THE BACKFILL IS TO BE TOP SOIL, TAMPED IN PLACE, PLANTED WITH MUSTARD AND RYE GRASS AND ADEQUATELY WATERED UNTIL GROWTH IS RESTORED.

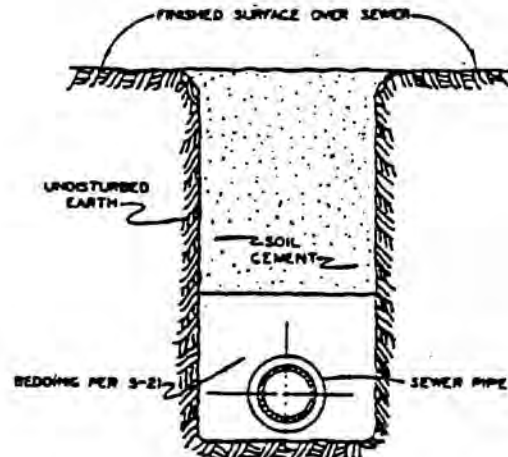

**CASE II
SOIL CEMENT BACKFILL**

1. TO BE USED IN SOFT SANDSTONE, SHALE, OR ROCK WHEN REQUIRED BY THE COUNTY ENGINEER; OR MAY BE USED IN LIEU OF CASE I, WITH THE APPROVAL OF THE COUNTY ENGINEER.
2. THE ENTIRE TRENCH SHALL BE BACKFILLED WITH SOIL-CEMENT ABOVE THE BEDDING SHOWN TO THE FINISHED SURFACE UNLESS OTHERWISE NOTED ON THE PLANS.
3. THE SOIL-CEMENT SHALL CONSIST OF ONE SACK OF PORTLAND CEMENT PER CUBIC YARD OF BACKFILL MATERIAL WITH SUFFICIENT FINES TO FILL ALL VOIDS. THE SOIL AND CEMENT SHALL BE THOROUGHLY DRY MIXED. AFTER MIXING, WATER SHALL BE ADDED IN A QUANTITY SUFFICIENT ONLY TO SLIGHTLY MOISTEN THE MIXTURE SO THAT IT CAN BE PACKED BY HAND INTO A BALL AND RETAIN ITS SHAPE BUT NOT WET THE HANDS. THE SOIL-CEMENT SHALL THEN BE MECHANICALLY RAMMED INTO PLACE IN THE TRENCH IMMEDIATELY AFTER THE WATER IS ADDED.

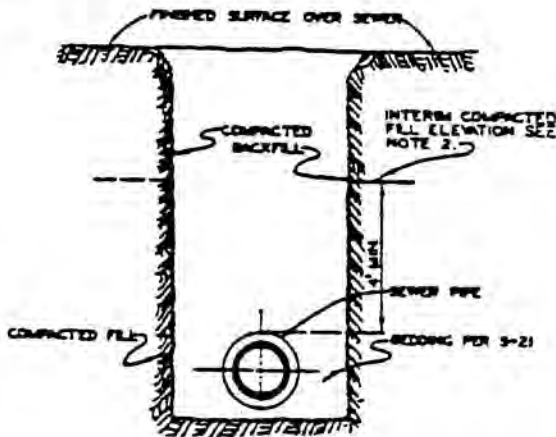

**CASE III
CERTIFIED COMPACTION**

1. TO BE USED WHEN SEWER IS LOCATED IN A COMPACTED FILL AREA BEING PLACED ACCORDING TO AN APPROVED GRADING PLAN.
2. THE SEWER PIPE MUST BE LAID IN A TRENCH EXCAVATED IN THE COMPACTED FILL SLOPE AND DEEP ENOUGH TO PROVIDE AT LEAST 4 FEET OF COVER OVER THE PIPE.
3. CERTIFICATION IS REQUIRED BY A SOIL TESTING LABORATORY AND SOILS ENGINEER THAT THE COMPACTION FOR THE BACKFILL MEETS THE GRADING PLAN REQUIREMENTS.

GENERAL NOTES

1. IN ALL CASES ANCHOR BLOCKS WILL BE REQUIRED IN ACCORDANCE WITH STANDARD PLAN S-24 UNLESS OTHERWISE NOTED ON THE PLANS.
2. ANY ALTERNATE MATERIALS, PLANTS OR METHODS MUST BE SPECIFICALLY APPROVED BY THE COUNTY ENGINEER.

EROSION PROTECTION IN STEEP SLOPES

COUNTY OF LOS ANGELES
DEPARTMENT OF PUBLIC WORKS

Assistant Deputy
ASSISTANT DEPUTY

County Engineer
COUNTY ENGINEER

COUNTY ENGINEER
STANDARD S-31

DATE: 3/80

DESIGN: *10443*
RCE

NOTE: TO BE USED FOR DEPTHS LESS THAN 5 FEET FROM THE TOP OF THE MANHOLE TO THE TOP OF THE SEWER PIPE

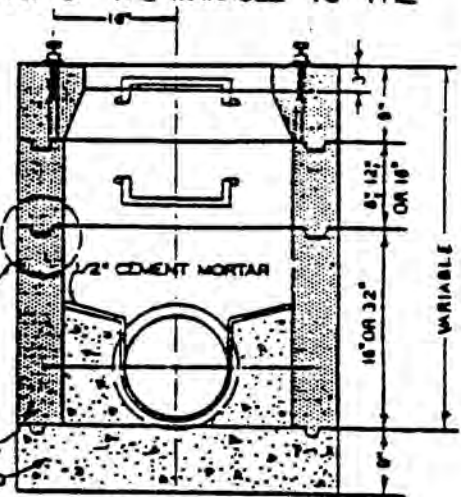
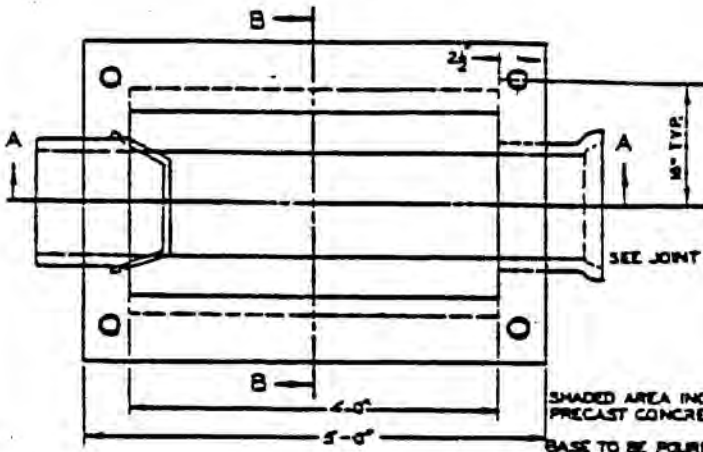

SECTION B-B
TYPE A

PRECAST BASE SECTION WITH OPENINGS PROVIDED

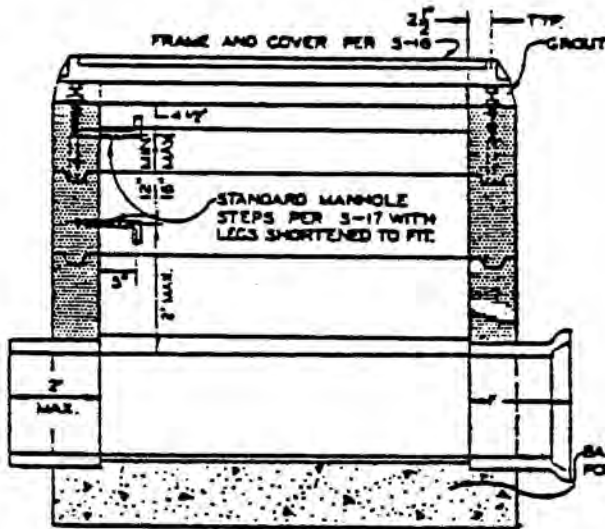

SECTION A-A

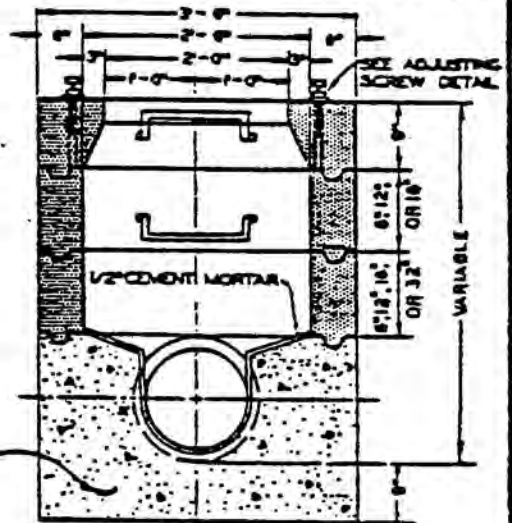

SECTION B-B
TYPE B

BASE AND CHANNELS POURED MONOLITHICALLY

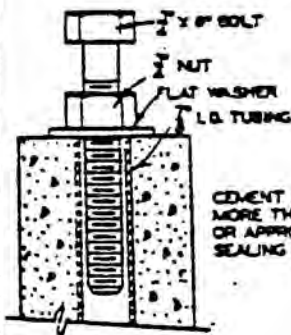

ADJUSTING
SCREW DETAIL

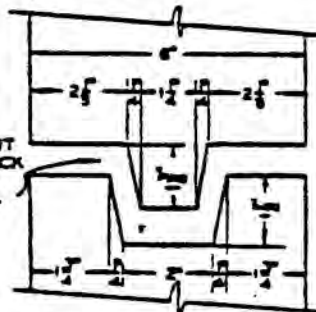

JOINT DETAIL

NOTES

1. CONCRETE FOR ALL PRECAST UNITS SHALL BE COMPACTLY VIBRATED IN THE FORMS. IT SHALL BE CURED ACCORDING TO APPROVED PRACTICE EITHER BY STEAM, SPRINKLING, MEMBRANE SOLUTION, OR A COMBINATION OF THESE. IT SHALL DEVELOP 3500 PSI OR GREATER STRENGTH IN 28 DAYS.
2. THE DEPTH OF CHANNELS SHALL EQUAL THE PIPE DIAMETER FOR ALL SIZES OF PIPE.
3. CHANNEL LOCATIONS AND OFFSETS TO BE PLACED AS SHOWN ON 3-7.
4. ALL FIELD POURED CONCRETE TO BE CLASS S20C2500 AND ALLOWED TO SET 24 HOURS BEFORE PLACING PRECAST UNITS.
5. ALL PRECAST UNITS SHALL BE REINFORCED FOR M-20 BRIDGE LOADING.
6. ALL CEMENT MORTAR SHOWN HEREON SHALL BE CLASS "D" FOR SECTION 20-31 OF STANDARD SPECIFICATIONS.

PRECAST CONCRETE SHALLOW MANHOLE

COUNTY OF LOS ANGELES
DEPARTMENT OF PUBLIC WORKS

Assistant Deputy
ASSISTANT DEPUTY

County Engineer
COUNTY ENGINEER

COUNTY ENGINEER
STANDARD

DATE: 3/80 S-32

DESIGN RCE
10683

I.

MINIMUM TRENCH WIDTH

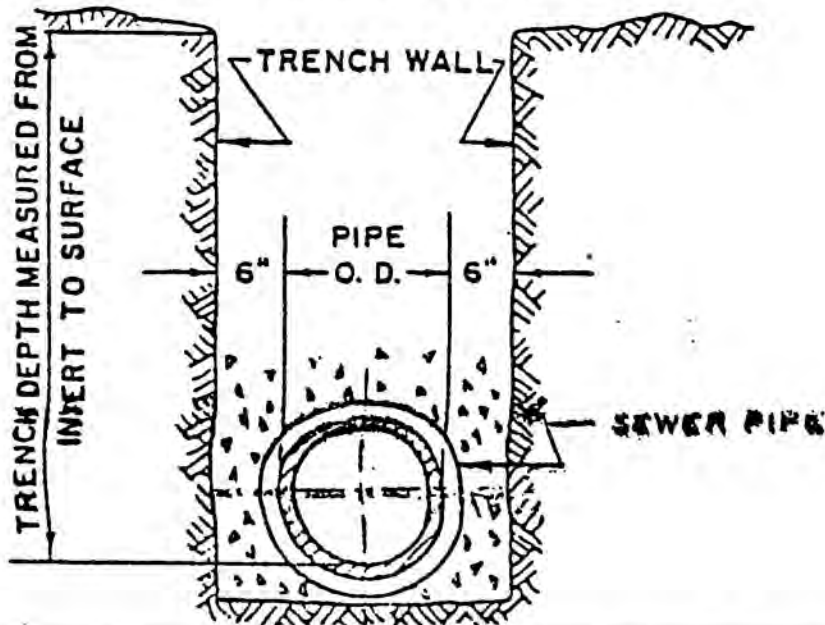

II.

MAXIMUM TRENCH WIDTH

MEASURED AT TOP OF PIPE

PIPE SIZE	DEPTH OF TRENCH					LESS THAN 10'
	18'-20'	16'-18'	14'-16'	12'-14'	10'-12'	
4" & 6"	2'-2"	2'-2"	2'-2"	2'-2"	2'-2"	NONE
8"	2'-3"	2'-3"	2'-4"	2'-4"	2'-6"	"
10"	2'-5"	2'-6"	2'-7"	2'-8"	2'-9"	"
12"	2'-8"	2'-9"	2'-9"	2'-11"	3'-1"	"
15"	2'-11"	3'-0"	3'-2"	3'-3"	3'-6"	"
18"	3'-3"	3'-4"	3'-6"	3'-8"	4'-0"	"
21"	3'-7"	3'-8"	3'-10"	4'-1"	4'-6"	"
24"	3'-9"	3'-11"	4'-2"	4'-5"	4'-10"	"
27"	4'-1"	4'-3"	4'-6"	4'-10"	5'-4"	"
30"	4'-4"	4'-7"	4'-10"	5'-3"	5'-10"	"
33"	4'-8"	4'-11"	5'-2"	5'-8"	6'-5"	"
36"	4'-11"	5'-2"	5'-6"	6'-1"	6'-11"	"

IF MAXIMUM ALLOWABLE WIDTH SPECIFIED IS EXCEEDED, SPECIAL BEDDING & CRADLING MUST BE PROVIDED PER S-21, AT CONTRACTOR'S EXPENSE.

ALLOWABLE TRENCH WIDTHS

COUNTY OF LOS ANGELES
DEPARTMENT OF PUBLIC WORKS

COUNTY ENGINEER
STANDARD

S-33

DATE: 3/80

DESIGN

RCE
10023

[Signature]
ASSISTANT DEPUTY

[Signature]
COUNTY ENGINEER

[Signature]

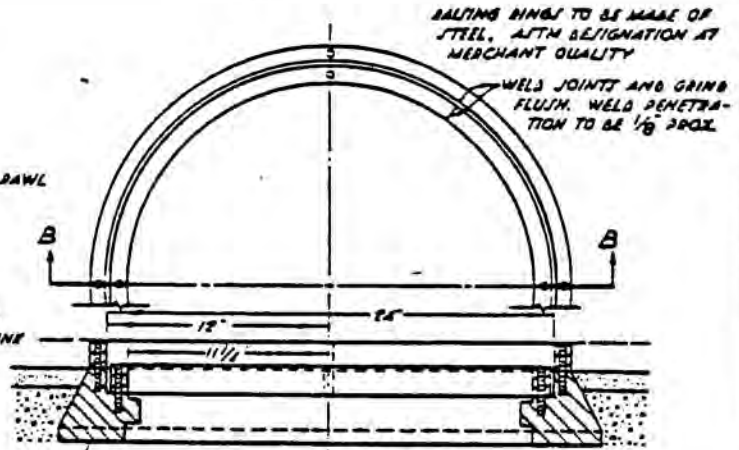
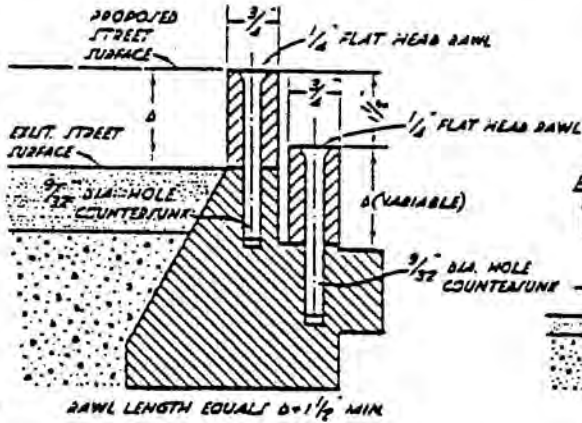

STANDARD MANHOLE FRAME PER J-35
SECTION B-B

STEEL RAISING RINGS

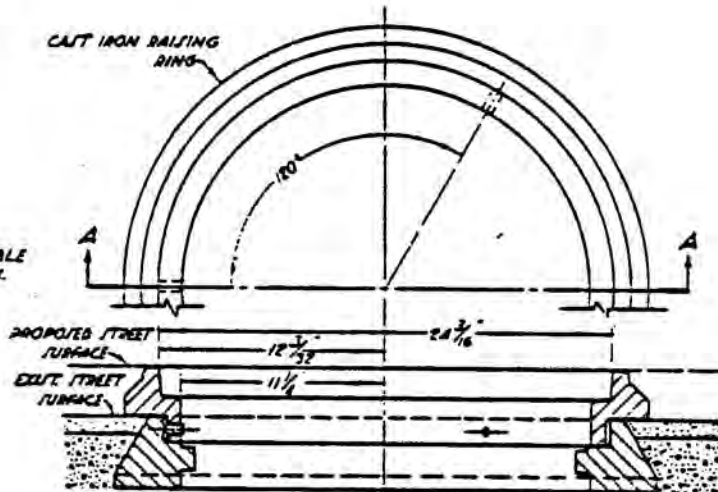
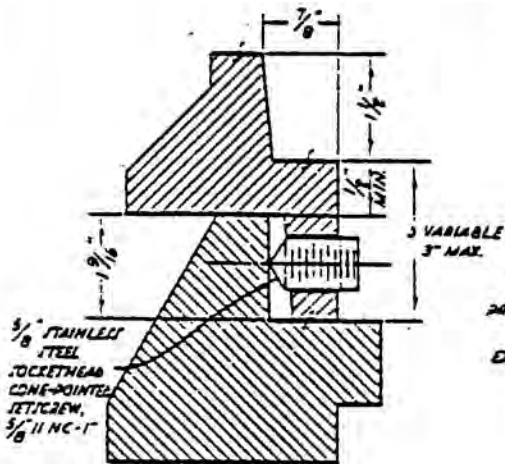

SECTION A-A

- NOTES:
- 1 MACHINE TESTY. OF CAST IRON RING.
 - 2 THE CAST IRON USED SHALL HAVE A TENSILE STRENGTH OF 30,000 LBS PER SQUARE INCH.

CAST IRON RAISING RINGS

- NOTES:
- THE METAL RAISING RINGS MAY BE USED IN LIEU OF THE REGULAR METHOD OF ADJUSTMENT UTILIZING MORTAR OR BRICK AND MORTAR UNDER THE FOLLOWING CONDITIONS.
- 1 RAISING RINGS MAY ONLY BE USED UPON WRITTEN APPROVAL OF THE COUNTY ENGINEER.
 - 2 ONLY ONE ADJUSTMENT WITH RAISING RINGS WILL BE ALLOWED ON ANY MANHOLE.
 - 3 MAXIMUM "d" SHALL BE 3 INCHES.

MANHOLE RAISING RINGS

COUNTY OF LOS ANGELES
DEPARTMENT OF PUBLIC WORKS

[Signature]
ASSISTANT COUNTY ENGINEER

[Signature]
COUNTY ENGINEER

COUNTY ENGINEER
STANDARD

DATE: 3/80

DESIGN

[Signature] RCE
10663

S-34

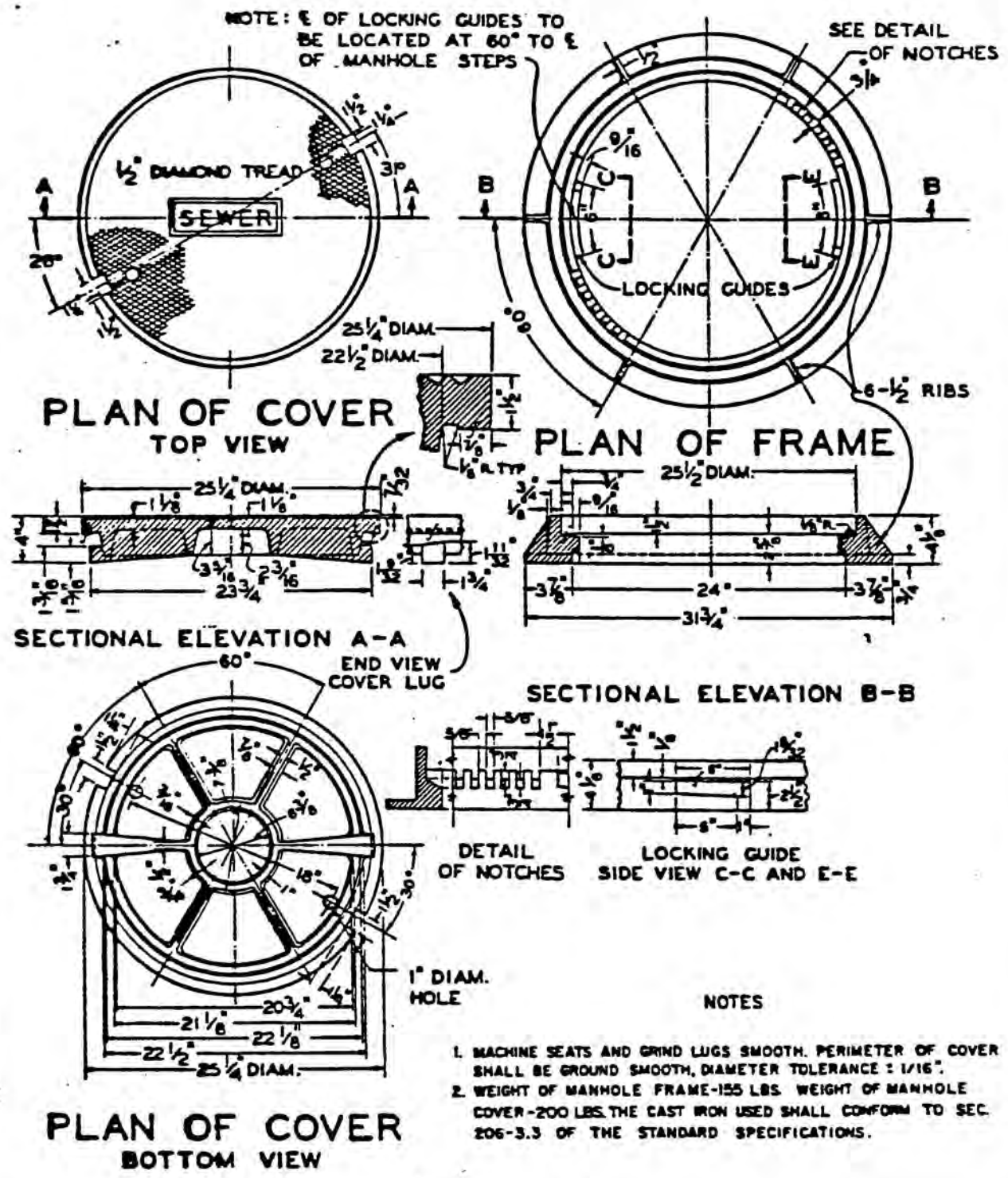

LOCKING MANHOLE FRAME & COVER

COUNTY OF LOS ANGELES
DEPARTMENT OF PUBLIC WORKS

COUNTY ENGINEER
STANDARD S-35
DATE: 3/80

Reed C. ...
ASSISTANT DEPUTY

Robert J. ...
COUNTY ENGINEER

DESIGN
...
RCE
10443

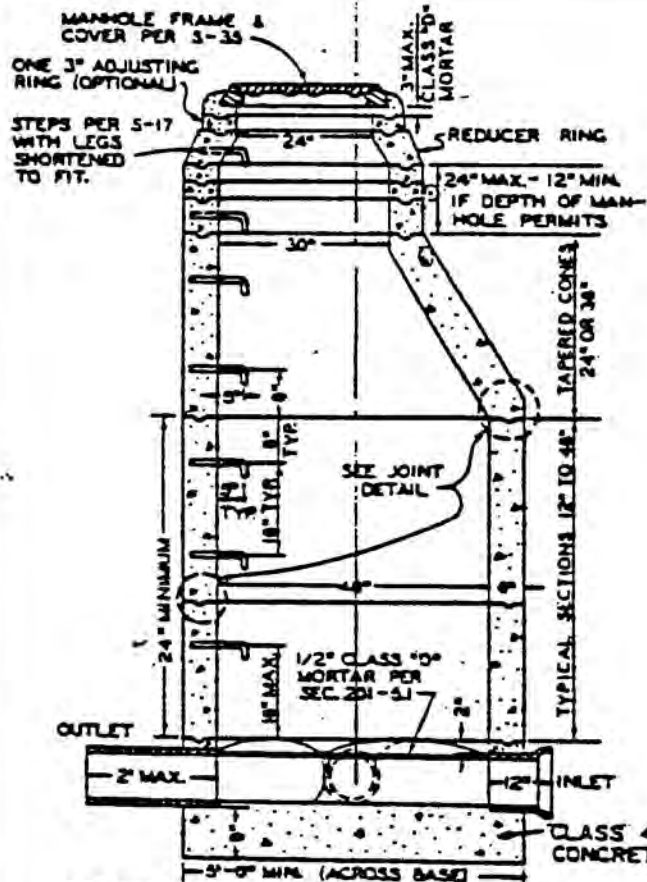

SECTIONAL ELEVATION A-A

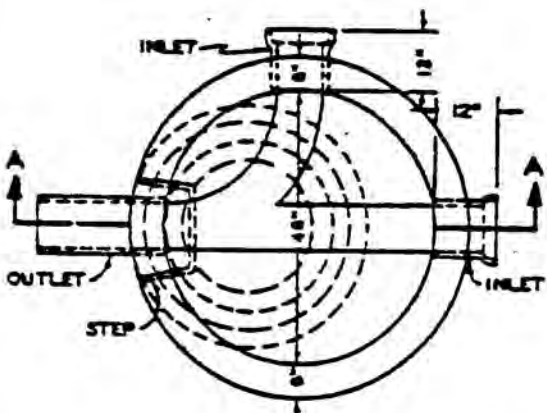
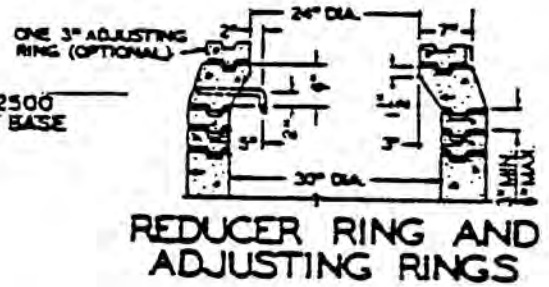
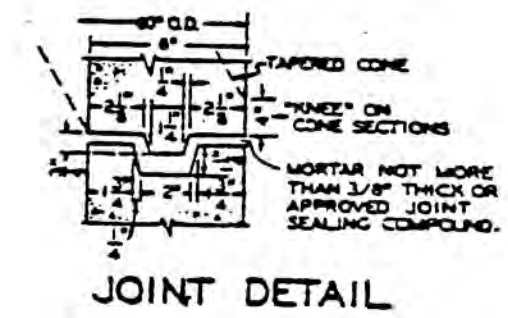

PLAN OF BASE

- NOTES**
1. CONCRETE BASE AND STUB WALLS SHALL BE POURED IN ONE OPERATION TO A POINT 2 IN. ABOVE THE INLET AND OUTLET PIPES. ALL PIPES SHALL BE RIGIDLY SUPPORTED BY TEMPORARY PIERS DURING THIS OPERATION. CONCRETE SHALL SET FOR 24 HOURS BEFORE PLACING PRECAST UNITS.
 2. CONCRETE FOR ALL PRECAST UNITS SHALL BE COMPACTLY VIBRATED IN THE FORMS. IT SHALL BE CURED ACCORDING TO APPROVED PRACTICE EITHER BY STEAM SPRINKLING, MEMBRANE SOLUTION, OR A COMBINATION OF THESE. IT SHALL DEVELOP 3500 PSI OR GREATER STRENGTH IN 28 DAYS.
 3. STEPS SHALL BE CAST IN PLACE AT TIME OF FABRICATION OR PLACED BETWEEN RINGS WITH 18 IN. MAXIMUM SPACING BETWEEN STEPS.
 4. THE DEPTH OF CHANNEL SHALL EQUAL THE PIPE DIAMETER FOR ALL SIZES OF PIPE. FOR SPECIAL CHANNELS IN TRAP OR GAUGING MANHOLES, SEE SPECIAL PLANS.
 5. THE TOP OF MANHOLE AND THE STEPS SHALL BE PLACED DIRECTLY OVER THE OUTLET OF THE STRUCTURE EXCEPT AS OTHERWISE NOTED ON PLANS.

NON-REINFORCED PRECAST CONCRETE MANHOLE

COUNTY OF LOS ANGELES
DEPARTMENT OF PUBLIC WORKS

COUNTY ENGINEER
STANDARD **S-36**
DATE: 3/80

[Signature]
ASSISTANT DEPUTY

[Signature]
COUNTY ENGINEER

DESIGN *[Signature]* RCE
10663

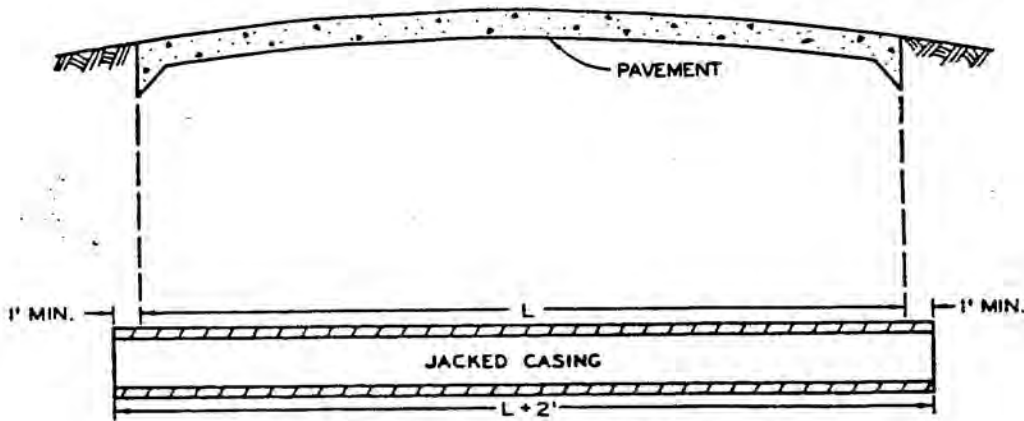

CROSSING UNDER ROADWAY

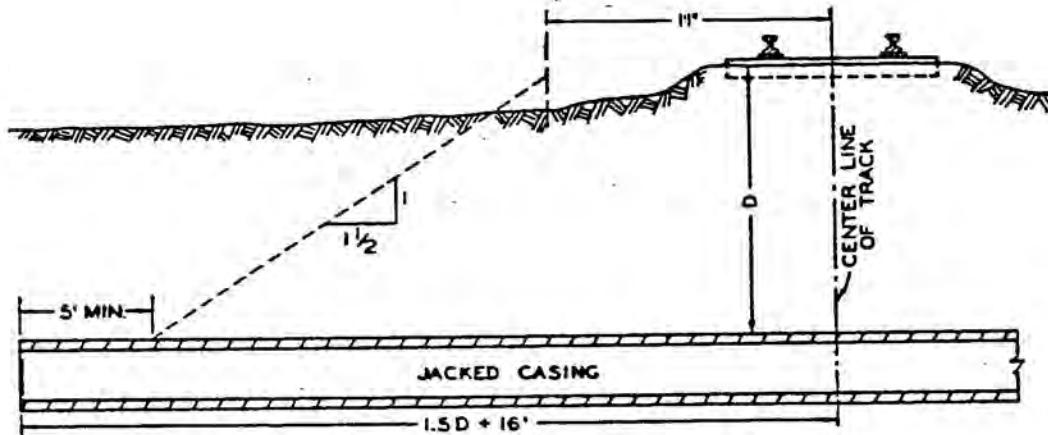

CROSSING UNDER RAILROAD

NOTES

1. JACKED STEEL CASING SHALL BE INSTALLED PER SECTION 305-2.3 OF THE STANDARD SPECIFICATIONS.
2. USE TYPE "D", OR "G" JOINTS PER SECTION 208-2 OF THE STANDARD SPECIFICATIONS FOR V.C.P. PIPE INSTALLED IN CASING.
3. THE CASING THICKNESS SHALL BE NOT LESS THAN 3/8".
4. FOR PIPE SIZES 18" AND UP, CHECK WITH COUNTY ENGINEER FOR DIAMETER AND THICKNESS OF CASING.
5. THE LENGTH OF CASING SHALL BE AS SHOWN ABOVE EXCEPT AS OTHERWISE INDICATED ON PLANS.
6. ANY ALTERNATE MATERIALS, SIZES, OR CONSTRUCTION METHODS MUST BE SPECIFICALLY APPROVED BY THE COUNTY ENGINEER.

DIAMETER OF STEEL CASING	
PIPE SIZE	CASING DIAMETER
6"	30"
8"	30" - 36"
10"	33" - 36"
12"	36" - 42"
15"	42" - 48"

JACKING PIPE

COUNTY OF LOS ANGELES
DEPARTMENT OF PUBLIC WORKS

Robert C. ...
ASSISTANT DEPUTY

Stephen J. ...
COUNTY ENGINEER

COUNTY ENGINEER
STANDARD

DATE: 5/81

DESIGN

... RCE 10043

S-37

SANITARY SEWERS

TO BE CONSTRUCTED IN

TRACT NO. 50000

PRIVATE CONTRACT NO. 13000

(INDEX)

2 SHEETS; 4 PAGES

SCALE: VERT. 1" = 4'
HORIZ. 1" = 40'

PREPARED IN THE OFFICES OF
COMPANY'S NAME
ADDRESS
BY: *Robert H. Stone*
REG. C.E. No. 001871 EXP. DATE

INSTRUCTION NOTE
PLANS MUST BE SIGNED
BEFORE BEING SUBMITTED

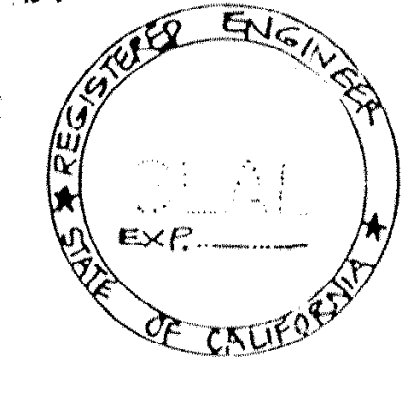

GENERAL NOTES:

- ELEVATIONS ARE IN FEET ABOVE U.S.C. & G.S. SEA LEVEL DATUM OF 1929
- NO REVISIONS SHALL BE MADE IN THESE PLANS WITHOUT THE APPROVAL OF THE DIRECTOR OF PUBLIC WORKS
- NO REPRESENTATIVE OF THE DEPARTMENT OF PUBLIC WORKS WILL SURVEY OR LAY OUT ANY PORTION OF THE WORK
- GRADES TO WHICH THIS IMPROVEMENT IS TO BE CONSTRUCTED ARE SHOWN ON PLANS AND PROFILES. GRADE POINTS FOR TOP OF CURBS, CENTERLINE OF STREETS, OR CENTERLINE OF ALLEYS ARE SHOWN BY CIRCLES ON PROFILES. AT ALL POINTS BETWEEN DESIGNATED POINTS THE GRADE SHALL BE ESTABLISHED SO AS TO CONFORM TO A STRAIGHT LINE DRAWN BETWEEN SAID DESIGNATED POINTS
- THE PRIVATE ENGINEER SHALL FURNISH THE DEPARTMENT OF PUBLIC WORKS WITH GRADE SHEETS AND STATIONING FOR ALL HOUSE LATERALS AND "Y" OR "T" BRANCHES AND SHALL PROVIDE STAKES FOR THEM AT THEIR PROPER LOCATIONS WITH STATIONING PLAINLY MARKED. ALL HOUSE LATERALS SHALL BE CONSTRUCTED IN A STRAIGHT ALIGNMENT AT RIGHT ANGLES FROM THE MAIN LINE SEWER EXCEPT AS SHOWN ON THE PLANS. HOUSE LATERALS FROM CHIMNEYS SHALL NOT HAVE A SLOPE OF LESS THAN 1/4" PER FOOT WITH THE MAIN LINE SEWER. ANY CHANGE IN ALIGNMENT SHALL BE REQUESTED IN WRITING BY THE PRIVATE ENGINEER
- THE PRIVATE ENGINEER SHALL FURNISH THE HOUSE LATERAL DEPTH AT THE PROPERTY LINE BELOW THE TOP OF CURB ELEVATION FOR EACH HOUSE LATERAL ON THE GRADE SHEET
- BEFORE WORK CAN BE STARTED, THE CONTRACTOR MUST OBTAIN A PERMIT TO EXCAVATE IN COUNTY STREETS FROM THE ROAD ELEMENT OF THE LOS ANGELES DEPARTMENT OF PUBLIC WORKS OVERSEER OFFICE NO. 60 AND PAY FEE TO THE DIRECTOR OF PUBLIC WORKS. A PERMIT FOR EXCAVATIONS AND TRENCHES FROM THE STATE OF CALIFORNIA, A DIVISION OF INDUSTRIAL SAFETY AND A CERTIFICATE OF WORKER'S COMPENSATION INSURANCE WITH THE DEPARTMENT OF PUBLIC WORKS, 488 W. VENEDIA AVE., LOS ANGELES, CALIFORNIA 90009-0009 MUST BE OBTAINED PRIOR TO THE START OF CONSTRUCTION. INSURANCE POLICY NO. 90009-0009 MUST BE NAMED AS THE CERTIFICATE HOLDER TO BE NOTIFIED 30 DAYS PRIOR TO CANCELLATION OF POLICY.
- IF WORK IS TO BE DONE IN STATE HIGHWAY, A PERMIT MUST BE OBTAINED FROM THE STATE OF CALIFORNIA, DIVISION OF HIGHWAYS, 120 SOUTH SPRING STREET, LOS ANGELES, CALIFORNIA
- APPROVAL OF THIS PLAN BY THE COUNTY OF LOS ANGELES DOES NOT CONSTITUTE A REPRESENTATION AS TO THE ACCURACY OF THE LOCATION OF OR THE EXISTENCE OR NON-EXISTENCE OF ANY UNDERGROUND UTILITY PIPE, OR STRUCTURE WITHIN THE LIMITS OF THIS PROJECT. THIS NOTE APPLIES TO ALL PAGES
- REFER TO SECTION 7.10.1.1 OF THE STANDARD SPECIFICATIONS, REGARDING SAFETY ORDERS
- PRIOR TO THE ISSUANCE OF THE REQUIRED SEWER CONSTRUCTION PERMIT, THE CONTRACTOR SHALL OBTAIN AND FILE WITH THE DEPARTMENT OF PUBLIC WORKS COPIES OF A PERMIT TO EXCAVATE IN COUNTY STREETS FROM THE ROAD ELEMENT AT THE DEPARTMENT OF PUBLIC WORKS, A PERMIT FOR EXCAVATIONS AND TRENCHES FROM THE STATE OF CALIFORNIA, A DIVISION OF INDUSTRIAL SAFETY AND A CERTIFICATE OF WORKER'S COMPENSATION INSURANCE WITH THE DEPARTMENT OF PUBLIC WORKS, 488 W. VENEDIA AVE., LOS ANGELES, CALIFORNIA 90009-0009. THE CONTRACTOR SHALL NOTIFY THE CONSTRUCTION DIVISION BY TELEPHONE FOR A PERMIT TO EXCAVATE IN COUNTY STREETS FROM THE ROAD ELEMENT (618) 458-3129 ANY WORK UNDER THIS CONTRACT.
- HOUSE LATERALS TO BE CONSTRUCTED WITH INVERTS AT PROPERTY LINE 8 FEET BELOW CURB GRADE EXCEPT AS NOTED
- WYE OR TEE BRANCHES MAY BE USED FOR CONNECTIONS TO MAINLINE SEWERS EXCEPT AS NOTED
- ALL STRUCTURES SHALL BE EITHER BRICK SEWER MANHOLES PER S-3 OR PRECAST CONCRETE SEWER MANHOLES PER S-36, EXCEPT AS NOTED
- PROVIDE STAKES ON THE PROPERTY LINE OR PROPERTY LINES PRODUCED AT RIGHT ANGLES TO THE SEWER LINE AT THE CENTERLINE OF EACH MANHOLE
- MANHOLE TOPS IN UNIMPROVED RIGHTS OF WAY TO BE SIX INCHES ABOVE FINISHED GRADE
- VITRIFIED CLAY PIPE JOINTS SHALL BE TYPE "D" OR "G" PER STANDARD SPECIFICATIONS SECTION 208-2
- IF A POWER POLE IS WITHIN THREE FEET OF THE SEWER, THE SEWER SHALL BE ENCASED, PER S-23, CASE II, TWO FEET ON EACH SIDE FROM THE POINT OF INTERFERENCE
- IF DURING THE COURSE OF CONSTRUCTION IT IS DETERMINED THAT THERE IS LESS THAN FOUR FEET COVER OVER THE TOP OF A MAINLINE OR HOUSE LATERAL V.C.P. SEWER WHICH IS NOT INDICATED ON THE PLANS, THE PIPE SHALL BE ENCASED PER S-23, CASE II, UNLESS OTHERWISE APPROVED BY THE DIRECTOR OF PUBLIC WORKS
- ALL JOINTS BETWEEN CAST IRON PIPE AND VITRIFIED CLAY PIPE SHALL BE MADE WITH A RUBBER SLEEVE JOINT, TYPE "C" OR "D", WITH BUSHING IF NECESSARY PER STANDARD SPECIFICATIONS, SECTION 208-2
- SEWERS TO BE TESTED FOR LEAKAGE PER SECTION 208-1.4 OF THE STANDARD SPECIFICATIONS AND SPECIAL PROVISIONS
- RESURFACE ALL TRENCHES WITHIN PAVED AREAS TO MEET LOS ANGELES COUNTY PUBLIC WORKS OR CALIFORNIA STATE HIGHWAY REQUIREMENTS IN ACCORDANCE WITH PERMITS
- FULL COMPLIANCE WITH SECTION 208-1.4 OF THE STANDARD SPECIFICATIONS WILL BE REQUIRED FOR BACKFILL WITHIN THE CERTIFICATION OF BACKFILL COMPACTION AND SAND EQUIVALENTS BY A QUALIFIED, REGISTERED TESTING LABORATORY SHALL BE PROVIDED BY THE PERMITTEE PRIOR TO THE ISSUANCE OF A CERTIFICATE OF PARTIAL ACCEPTANCE.
- SPECIAL BACKFILL INCREASED CONSTRUCTION (IN BACKFILL TRENCH AND REPLACE OTHER EARTH SO AS TO ACHIEVE THE NATURAL OR FINISHED GRADES AND SLOPES SHOWN ON THE GRADING PLAN APPROVED FOR THIS DEVELOPMENT BY THE BUILDING AND SAFETY DIVISION (B) ALL BACKFILL AND EARTH REPLACE SHALL BE COMPACTED TO A MINIMUM OF 90% OF MAXIMUM DENSITY PER A.S.T.M. METHOD OR TEST D95 AS MODIFIED. ACCEPTABLE CERTIFICATION OF SUCH COMPACTION SHALL BE SUBMITTED TO THE CONSTRUCTION DIVISION, PUBLIC WORKS DEPT.

CONSTRUCTION NOTES:

- WORK SHALL BE CONSTRUCTED ACCORDING TO THE STANDARD SPECIFICATIONS FOR PUBLIC WORKS CONSTRUCTION (1988 EDITION) AND COUNTY ENGINEER SPECIAL PROVISIONS FOR THE CONSTRUCTION OF SANITARY SEWERS DATED JULY 31, 1989, AND SHALL BE PROSECUTED ONLY IN THE PRESENCE OF THE COUNTY ENGINEER.
- THE CONTRACTOR SHALL NOTIFY THE CONSTRUCTION DIVISION BY TELEPHONE FOR A PERMIT TO EXCAVATE IN COUNTY STREETS FROM THE ROAD ELEMENT (618) 458-3129 ANY WORK UNDER THIS CONTRACT.
- HOUSE LATERALS TO BE CONSTRUCTED WITH INVERTS AT PROPERTY LINE 8 FEET BELOW CURB GRADE EXCEPT AS NOTED
- WYE OR TEE BRANCHES MAY BE USED FOR CONNECTIONS TO MAINLINE SEWERS EXCEPT AS NOTED
- ALL STRUCTURES SHALL BE EITHER BRICK SEWER MANHOLES PER S-3 OR PRECAST CONCRETE SEWER MANHOLES PER S-36, EXCEPT AS NOTED
- PROVIDE STAKES ON THE PROPERTY LINE OR PROPERTY LINES PRODUCED AT RIGHT ANGLES TO THE SEWER LINE AT THE CENTERLINE OF EACH MANHOLE
- MANHOLE TOPS IN UNIMPROVED RIGHTS OF WAY TO BE SIX INCHES ABOVE FINISHED GRADE
- VITRIFIED CLAY PIPE JOINTS SHALL BE TYPE "D" OR "G" PER STANDARD SPECIFICATIONS SECTION 208-2
- IF A POWER POLE IS WITHIN THREE FEET OF THE SEWER, THE SEWER SHALL BE ENCASED, PER S-23, CASE II, TWO FEET ON EACH SIDE FROM THE POINT OF INTERFERENCE
- IF DURING THE COURSE OF CONSTRUCTION IT IS DETERMINED THAT THERE IS LESS THAN FOUR FEET COVER OVER THE TOP OF A MAINLINE OR HOUSE LATERAL V.C.P. SEWER WHICH IS NOT INDICATED ON THE PLANS, THE PIPE SHALL BE ENCASED PER S-23, CASE II, UNLESS OTHERWISE APPROVED BY THE DIRECTOR OF PUBLIC WORKS
- ALL JOINTS BETWEEN CAST IRON PIPE AND VITRIFIED CLAY PIPE SHALL BE MADE WITH A RUBBER SLEEVE JOINT, TYPE "C" OR "D", WITH BUSHING IF NECESSARY PER STANDARD SPECIFICATIONS, SECTION 208-2
- SEWERS TO BE TESTED FOR LEAKAGE PER SECTION 208-1.4 OF THE STANDARD SPECIFICATIONS AND SPECIAL PROVISIONS
- RESURFACE ALL TRENCHES WITHIN PAVED AREAS TO MEET LOS ANGELES COUNTY PUBLIC WORKS OR CALIFORNIA STATE HIGHWAY REQUIREMENTS IN ACCORDANCE WITH PERMITS
- FULL COMPLIANCE WITH SECTION 208-1.4 OF THE STANDARD SPECIFICATIONS WILL BE REQUIRED FOR BACKFILL WITHIN THE CERTIFICATION OF BACKFILL COMPACTION AND SAND EQUIVALENTS BY A QUALIFIED, REGISTERED TESTING LABORATORY SHALL BE PROVIDED BY THE PERMITTEE PRIOR TO THE ISSUANCE OF A CERTIFICATE OF PARTIAL ACCEPTANCE.
- SPECIAL BACKFILL INCREASED CONSTRUCTION (IN BACKFILL TRENCH AND REPLACE OTHER EARTH SO AS TO ACHIEVE THE NATURAL OR FINISHED GRADES AND SLOPES SHOWN ON THE GRADING PLAN APPROVED FOR THIS DEVELOPMENT BY THE BUILDING AND SAFETY DIVISION (B) ALL BACKFILL AND EARTH REPLACE SHALL BE COMPACTED TO A MINIMUM OF 90% OF MAXIMUM DENSITY PER A.S.T.M. METHOD OR TEST D95 AS MODIFIED. ACCEPTABLE CERTIFICATION OF SUCH COMPACTION SHALL BE SUBMITTED TO THE CONSTRUCTION DIVISION, PUBLIC WORKS DEPT.

B.M. M.E. 55 ELEV. 110.803
NORTHWEST CORNER "C" STREET AND
MAJOR ROAD L & T 5 FT. W. OF W.
END OF CURB RETURN
MALIBU QUAD. 19 78

INSTRUCTION NOTE
AN ACCEPTABLE BENCH MARK IS TO BE SHOWN ON ALL PLANS
NO EQUATIONS BETWEEN BENCH MARK AND PLAN DATUM AUTHORIZED

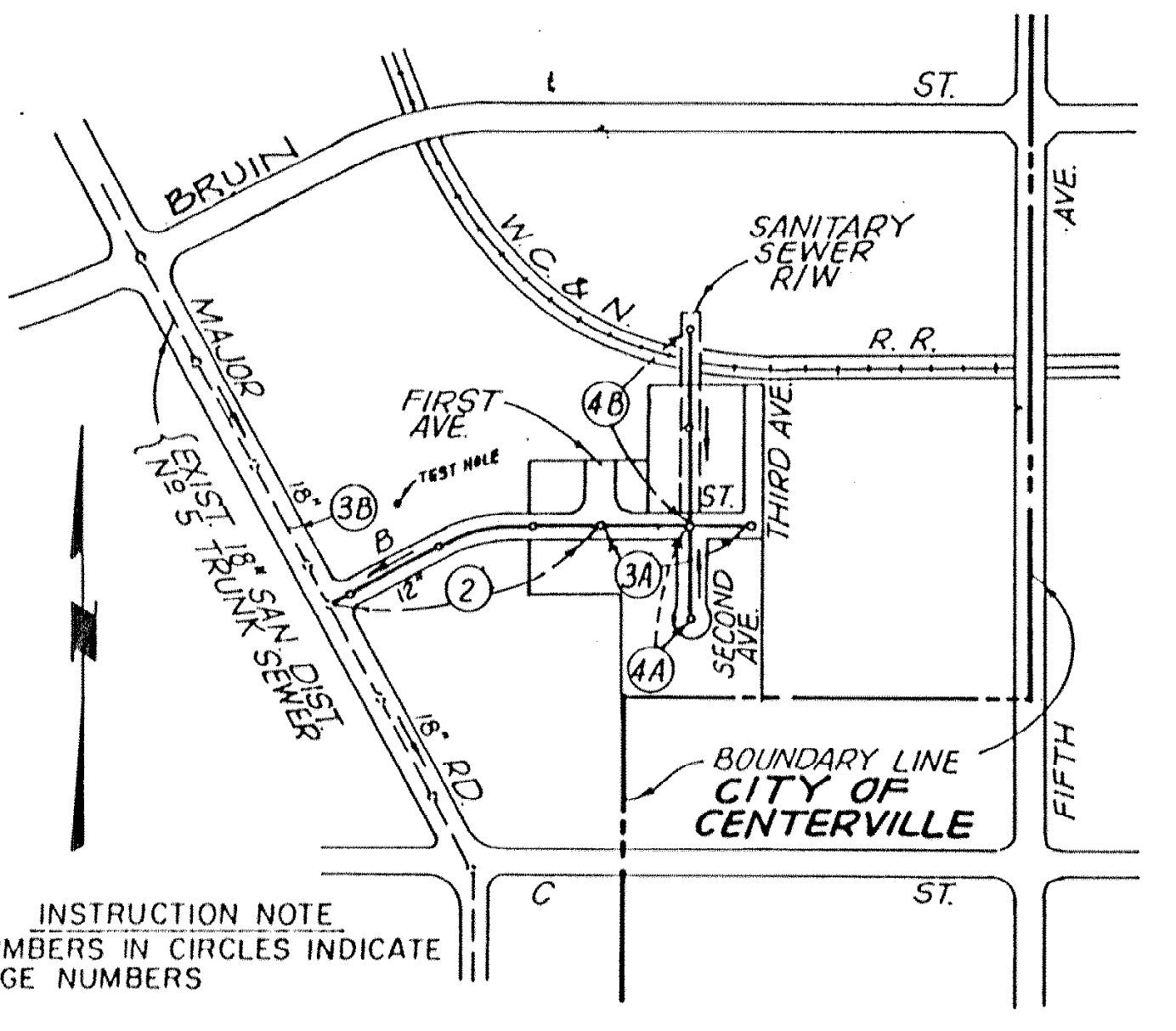

INDEX MAP
P.C. 13000 TR. NO. 50000
SCALE: 1" = 600'
THOMAS GUIDE PG.

GENERAL INSTRUCTION NOTES
IF IN A CONTRACT CITY CHANGE THE WORD "COUNTY TO CITY"
SUB-MINIMUM GRADES TO BE USED ONLY WITH PERMISSION OF THE
DEPARTMENT OF PUBLIC WORKS
DOUBLE SCALE IN THE PROFILE MUST BE APPROVED BY THE
DIRECTOR OF PUBLIC WORKS (ALL PAGES MUST USE SAME SCALE)
PLACE MANHOLES ON EVEN STATIONS OR 25 FT. STATIONS WHERE
PRACTICABLE
MAXIMUM MANHOLE DISTANCE TO BE 350 FEET

INSTRUCTION NOTE
IF IT IS NECESSARY TO JOIN TWO PAGES OF TRACING
CLOTH TO MAKE A STANDARD SIZE SHEET, IT IS REQUIRED
THAT THE JOINT BE MADE BY LAPPING THE EDGES 1/2
INCH AND SEWING SECURELY. PLANS SHALL CONSIST OF
STANDARD SIZE SHEETS ONLY.

DOUBLE SCALE
(WHEN APPLICABLE)
SEE GENERAL NOTE BELOW

SEWER GRADES

PIPE SIZE	MINIMUM	SUB-MINIMUM
4" & 6"	2.00%	NOT ALLOWED
8"	0.40%	0.24%
10"	0.32%	0.20%
12"	0.24%	0.16%
15"	0.16%	0.12%
18"	0.14%	0.08%
21"	0.12%	0.08%
24"	0.10%	0.08%

INSTRUCTION NOTE
A.B.S., A.B.S. COMPOSITE, OR P.V.C. PIPE MAY BE USED
IN LIEU OF V.C.P. IF IT CONFORMS TO THE CONDITIONS
OF USAGE CONTAINED IN PART IV, PLASTIC SEWER
PIPE OF THE "SPECIAL PROVISIONS" FOR THE CON-
STRUCTION OF SANITARY SEWERS. SPECIAL APPROVAL
MUST BE OBTAINED FROM THE SANITARY ENGINEERING
SECTION BEFORE USING ANY MATERIALS OTHER THAN
V.C.P. EITHER PLANS MUST BE APPROVED SHOWING THE
ALTERNATE PIPE MATERIAL OR A LETTER MUST BE SUB-
MITTED BY THE DESIGN ENGINEER REQUESTING THE USE
OF THE ALTERNATE MATERIAL.

PLAN REVISION NOTE

REVISION NO.	DATE
(DESCRIPTION OF REVISION IN FULL INCLUDING PAGE NUMBER(S) AND STATION INVOLVED.)	

APPROVED _____
DEPT. OF PUBLIC WORKS

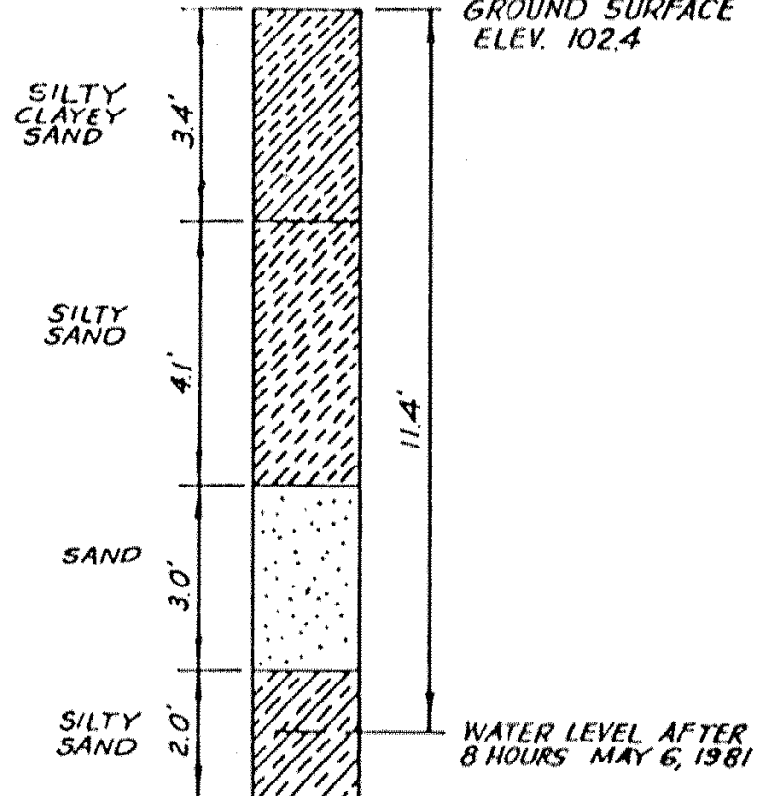

TEST HOLE DATA

NE. COR. "B" ST. & MAJOR RD.
INSTRUCTION NOTE
TEST BORING REQUIRED ON
REQUEST OF THE DEPT. OF
PUBLIC WORKS

NOTE: THIS SAMPLE DRAWING IS FOR DESIGN STANDARDS ONLY.
A NEW FORMAT IS AVAILABLE ON DISKETTE ANY QUESTIONS CALL (626) 458-4921

